

FG

WOOD CONNECTORS®

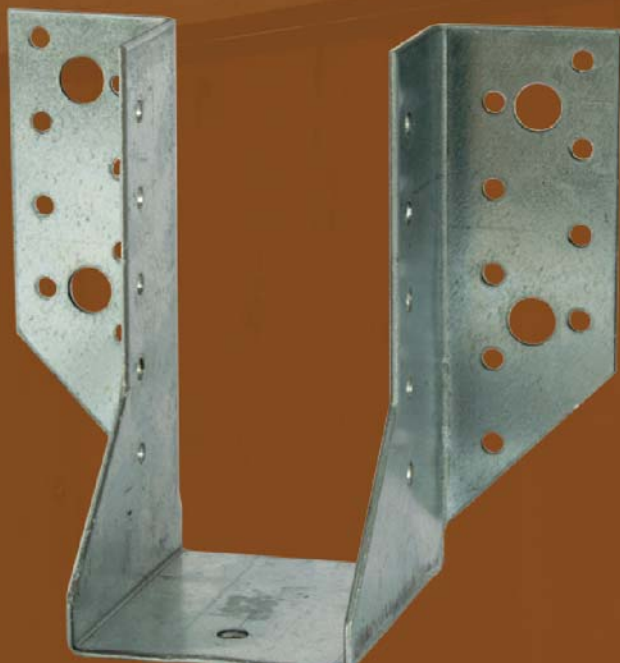

Quality by
— europe
pqb

WOOD CONNECTORS

All rights reserved.
This catalog may not be reproduced
in whole or in part without the prior
written approval of pgb-Europe nv.

© pgb-Europe nv 2020 - 01



FG
WOOD CONNECTORS®



pgb-fasteners®



pfs⁺-screw®



Smart®



COSMOS®
Hand Tools for Professionals



SHARPWARE™
Power Tool Accessories



HAPAX

pgb-Europe

EN

pgb-Europe is a Belgian family-owned company specialised in the distribution of fasteners, fixings and hand tools. Our vast range of products allows us to meet the individual needs of every customer.

Intelligent fastening solutions :

We want to be a leading company in the domestic market of our field. pgb-Europe distinguishes itself through knowhow, excellent product quality, a high delivery rate and customer-oriented service and sound advice. We stand for a long term partnership with a clear win-win situation, by offering products with added-value. A strong emphasis is put on finding the best and most cost-efficient solution for our clients.

pgb-Europe

FR

pgb-Europe est un fournisseur complet pour les systèmes de fixation et l'outillage. Avec notre large assortiment de produits, nous avons toujours une solution pour nos clients.

Intelligent fastening solutions :

Nous aspirons à devenir une société idéale dans notre secteur. pgb-Europe se distingue par les moyens de knowhow, par une qualité de produits irréprochable, par des livraisons régulières et par un excellent service clientèle. Nous sommes également désireux de garder nos partenaires grâce à un esprit de "gagnant" et grâce à la valeur ajoutée de nos produits. Notre seul but est de trouver la meilleure solution pour notre clientèle.

pgb-Europe

NL

pgb-Europe is een Belgische KMO gespecialiseerd in het verdelen van bevestigingsmaterialen en handgereedschappen. Door onze jarenlange ervaring en het uitgebreide productassortiment bieden we elke klant een totaaloplossing.

Intelligent fastening solutions :

Wij streven om een toonaangevend bedrijf te zijn binnen onze sector. pgb-Europe onderscheidt zich door knowhow, uitstekende productkwaliteit, een hoge uitleveringsgraad en een klantgerichte service. Wij gaan voor partnerships op lange termijn met een duidelijke win-win situatie, door onze producten van toegevoegde waarde te voorzien. De nadruk ligt steeds op het vinden van de meest gepaste en kostenefficiënte oplossing voor de klant.

pgb-Europe

DE

Die Belgische Firma pgb-Europe NV ist Ihr zuverlässiger Partner für alle Befestigungstechnik und Handwerkzeuge. Unsere langjährige Erfahrung und tiefes Angebotsspektrum tragen dazu bei. Für sie einen kompletten Lösungsanbieter zu bedeuten, der Ihnen das komplette Beschaffungsmanagement spürbar vereinfacht.

Intelligent fastening solutions :

pgb verfügt über ein umfangreiches Lieferprogramm und differenziert sich auf dem Markt durch qualitativ hochwertige Produkte, seine Dienstleistung, eine zuverlässige Auslieferungsgrad und Innovation. Und selbstverständlich geht die Betreuung von Kunden bei pgb immer noch weit über das Übliche Maß. Sie erhalten bei uns alles aus einer Hand und wir bieten Ihnen maßgeschneiderderte Lösungen. Ausgangspunkt ist eine langjährige, angenehme Geschäftsbeziehung wobei Sie uns als wichtigen Partner schätzen lernen, der stets mit Engagement und Service Ihre Aufträge termingerecht abwickeln werden.



Sustainability

We promote environmental friendly products. Therefore we use chromeVI free zinc plating. For our packaging we use recycled cardboard.

Ook bij pgb-Europe dragen we ons groene steentje bij voor verantwoord ondernemen. Zo worden onze schroeven chromeVI-vrij verzinkt en gebruiken we gerecycleerd karton voor onze verpakking.

Chez pgb-Europe, nous nous responsabilisons également en respectant l'environnement: en effet, notre visserie en zingué ne contient pas de chromeVI et nos produits sont emballés dans des cartons entièrement recyclables.

Auch die pgb Gruppe unterstützt und fördert Umweltbewusstes Handeln. Deshalb legt pgb-Europe ein lagerhaltiges Programm mit Chrom VI-freier Dickschichtpassivierung auf und verwendet Verpackungen aus rezykliertem Karton.



Important notice

Despite the fact that most of the products we supply do not fall under the scope of the RoHS regulations pgb-Europe wants to be active and supportive when dealing with all environmental issues and requirements in general. Therefore Cr6+ yellow zinc plated article items (items with 'GZ' symbol) will be replaced, as much as possible, by white zinc plated article items (Cr3+).

Images

Images, dimensions and holes might subject to variations. Afbeeldingen, afmetingen en gatenpatronen kunnen wijzigingen ondergaan. Images, dimensions et trous pourraient subir des modifications. Bilder, Abmessungen und Löcher können sich verändern.

Symbol lexicon



Zinc plated
Verzinkt
Zingué
Verzinkt



Sendzimir zinc plated
Sendzimir verzinkt
Zingué Sendzimir
Sendzimir verzinkt



Yellow Zinc plated
Geelverzinkt
Zingué jaune
Verzinkt Gelb



Hot dip galvanized
Vuurverzinkt
Galvanisé à chaud
Feuerverzinkt



Deltacoll® Black



Chrome plated
Verchromd
Chromé
Chromiert



Nickel plated
Vernikkeld
Nicklé
Vernickelt



Stainless steel AISI 304
Roestvrij staal AISI 304
Acier inox AISI 304
Rostfrei Stahl AISI 304



Stainless steel AISI 316
Roestvrij staal AISI 316
Acier inox AISI 316
Rostfrei Stahl AISI 316



Plasticized
Geplastificeerd
Plastifié
Plastifiziert



Nylon, zinc plated
Nylon, verzinkt
Nylon, zingué
Nylon, verzinkt



Polypropylene
Polypropyleen
Polypropylène
Polypropylene



Wood
Hout
Bois
Holz



ETA - European
Technical approval



CE | EN conform
Conform CE | EN
Conformité CE | EN
CE | EN Konform



Selling unit
Verkoopseenheid
Unité de vente
Verkaufseinheit





www.pgb-europe.com

Product Index

	FG100	Screw nails - Flat conical head Schroefnagel - Ronde platte kop Pointes torsadées - Tête platte conique Schraubennagel - Flachkopf-kegel	p. 16		FG153	Roof ridge fixing - left + right Verbindingshoek - links + rechts Pattes de solivage - gauche + droite Sparrenpfettenanker - Links + Rechts	p. 24
	FG101	Barbed nails Ringnagels Pointes annelées Rillennägel	p. 16		FG154	Chocks Gordingklos Echantignoles Knaggen	p. 25
	FG102	Clamp nails Klisjesnagel Pointes pour tasseaux Klisjesnagel	p. 16		FG155	Roof ridge fixing - "A" Type Hoekverbinder - Type A Patte de solivage - Typ A Sparrenpfettenanker - Typ "A"	p. 25
	FG111	HAPAX Adjustment blocks HAPAX Uitvulplaatjes HAPAX Cales bardages HAPAX Justierklotz	p. 17		FG156	Nailing gusset Spijkerplaat Plaque à clouer Lochplatte	p. 26
	FG121	Joist hanger - Type A exterior lip Zware balkendr. - Type A uitw. lippen Support poutre - Forme A extérieures Balkenschuh - Form A aussen abgewink.	p. 17		FG158	Multinailing gusset Multi-nagelplaat Platinne à clous Nagelplatte	p. 26
	FG122	Joist hanger - Inner folded Zware balkendrager inwendige lippen Sabots à ailes intérieures Balkenschuh nach innen abgewinkelt	p. 18		FG159	Flat connector - Heavy type Koppelplaat - Zwaar type Platinne d'assemblage - Typ lourde Flachverbinder - Schwer	p. 27
	FG123	Joist hanger - 2-parts (left + right) Zware balkendr. - 2-delig (l + r) Sabots - 2 éléments (gauche + droite) Balkenschuh - 2-teilig (links + rechts)	p. 20		FG160	Anchor plate Verbindingsplaat Platinne d'assemblage Lochplatten	p. 27
	FG126	Beamsupport with long lip Balkdrager met lange lip Support de poutre avec lèvre longue Balkenschuh mit lange Lasche	p. 20		FG161	Coat rack plate Kapstok ophangoog Platine porte-manteau Rahmenöse	p. 28
	FG128	Beamsupport without lip Balkdrager zonder lip Support de poutre sans lèvre Balkenschuh ohne Lasche	p. 21		FG162	Fish plate Koppelplaat Plaque d'assemblage Flachverbinder	p. 28
	FG136	Joist hanger with strap Raveeldrager met strip Support poutre à lèvres à plier Pfettenverbinder	p. 22		FG163	Strap anchor Koppelanker Ancrage d'accouplement Flachverbinder	p. 28
	FG141	Universal coner joint Universeel hoek gripanker Patte-equerre d'ancrage mod. universel Eckverbinder universel	p. 22		FG164	Strap anchor Koppelanker Ancrage d'accouplement Flachverbinder	p. 29
	FG142	Light joist hanger - "U" Type Regeldrager - Type "U" Support de poutre - Forme "U" Balkenschuh - Typ "U"	p. 23		FG166	Connector - Narrow type Verbindingsplaat - Smal type Platine de connection - Type étroite Verbindungsplatte - Schmal	p. 29
	FG144	Truss clip - vertical Trussclip - verticaal Pied de fermette - Verticalement Balkenverbinder - Vertikal	p. 23		FG168	T-anchor plate - Connecting IPN/wood Verbindingsplaat - IPN/hout Ancrages IPN - Liaison IPN/bois HE-anker T-träger/holzbalken	p. 30
	FG151	Purlin joint Gordinglas Cantilever Balkenverbinder	p. 24		FG169	Anchor square Betonanker Equerre d'ancrage à sceller Betonflachstahlanker	p. 30



























Product Index

	FG170	Corrugated assembly belt/plast. box - 10 m Gegolfde gaatjesb. in cassette - 10 m Bande perfo ondulée en cassette - 10 m Windrispenband gewellt in cassette - 10 m	p. 31		FG206	Mounting tabs for wooden frames Raamklauw voor houten ramen Pattes de fixation de fenêtres bois Montagelaschen für Holzrahmen	p. 37
	FG171	Straight assembly belt/plastic box - 10 m Rechte gaatjesb. in cassette - 10 m Bande perfo droite en cassette - 10 m Windrispenband recht in cassette - 10 m	p. 31		FG210	Multi angle bracket - 90° Kozijnhoek met ril - 90° Equerre nervurée droite - 90° Winkel mit Rille - 90°	p. 37
	FG172	Straight assembly belt - 10 m Rechte gaatjesband - 10 m Bande perforée droite - 10 m Windrispenband recht - 10 m	p. 32		FG227	Narrow square Stoelhoek Equerre chaise Stuhlwinkel	p. 38
	FG173	Straight assembly belt - 25 m Rechte gaatjesband - 25 m Bande perforée droite - 25 m Windrispenband recht - 25 m	p. 33		FG228	Narrow square - Heavy type Dorpelhoek - Zwaar type Equerre porte - Forme lourde Winkelverbinder schwer	p. 39
	FG174	Angled lug Beton hoekanker Equerre de fixation béton Betonwinkel	p. 33		FG230	Reinforced corner skew - 135° Neusijzer - 135° Equerre asymétrique - 135° Winkelverbinder - 135°	p. 39
	FG175	Straight assembly belt - 5 m Rechte gaatjesband - 5 m Bande perforée droite - 5 m Windrispenband recht - 5 m	p. 33		FG231	Merging square - 135° Koppelplaat - 135° Equerre d'assemblage - 135° Strebenverbinder - 135°	p. 39
	FG178	Straight assembly belt - 50 m Rechte gaatjesband - 50 m Bande perforée droite - 50 m Windrispenband recht - 50 m	p. 34		FG233	Cornice bracket - 90° Kroonlijsthaak - 90° Equerre de corniche - 90° Karniesenwinkel - 90°	p. 40
	FG179	Ridge piece support Ruitersleu Cavalier rehausse pour charpente Firstlattenhalter	p. 34		FG235	Assembly square scalene Ongelijkbenige versterkingshoek Equerre simple scalène Lochplattenwinkel ungleichschenkllich	p. 40
	FG185	Reinforced adjustable square Verstelbaar hoekanker met ril Equerre ajustable renforcé Winkelverbinder abstelbaar mit Sicke	p. 35		FG236	Assembly square - Multi holes Versterkingshoek - Multigaten Equerre - Multi-trous Lochplattenwinkel	p. 41
	FG186	Reinforced square Hoekanker met ril en afgeschuinde hoeken Equerre renforcé Winkelverbinder mit Sicke	p. 35		FG237	Door angle - 90° Raamhoek - 90° Equerre pour meubles - 90° Flachwinkel - 90°	p. 42
	FG187	Adjustable square Verstelbaar hoekanker Equerre ajustable Winkelverbinder mit Kombiloch	p. 35		FG240	T-ridge T-verbindingsplaat Equerre modèle T T-winkel	p. 42
	FG188	Square - Heavy type Hoekanker - Zwaar type Equerre - Forme lourde Winkelverbinder - schwer	p. 36		FG241	Assembly square - Multi holes Versterkingshoek - Multigaten Equerre - Multi-trous Lochplattenwinkel	p. 43
	FG189	Heavy reinforced square Hoekanker met ril Equerre renforcé - Forme lourde Winkelverbinder mit Verstärkungs-Sicke	p. 36		FG242	Frame connector Versterkingshoek Equerre symétrique Breitwinkel	p. 43
	FG190	Anchor square for wood/concrete Hoekanker voor hout/beton Equerre d'ancrage pour bois/béton Winkelverbinder holz/beton	p. 37		FG243	T-ridge large T-verbindingsplaat - Breed Equerre en T - Large T-Winkel - breit	p. 44

Product Index

	FG251	Straight hinge Rechte heng Penture droite Ladenband gerade	p. 46		FG303	Straight strap hinge - Light version Staaitheng - Licht type Penture anglaise double - Forme légère Scharnier - leicht	p. 56
	FG252	Hinge - Rustica Heng - Rustica Penture - Rustica Ladenband - Rustica	p. 47		FG304	Double tailhinge - Heavy version Dubbele staartscharnier - Zwaar type Penture double - Forme forte Doppelten Kistenband - schwer	p. 57
	FG253	Hinge with point Heng met punt Penture pointu Ladenband mit Punkt	p. 47		FG307	Adjustable anchor Verstelbaar instortanker m. pin Ancrage réglable Stützenfuss verstellbar m. Stange	p. 57
	FG254	Shutter hinge - T-model Draailuikheng - T model Penture équerre pièce interm. - Forme T Winkelband - geschweisst	p. 49		FG310	Column shoe with rebar - L type Balkenvoet met betonijzer - L type Pied de poteau avec fer de béton - Forme L Pfostensträger mit Riffeldolle - Form L	p. 57
	FG255	Plate pintle Plaatduim Gond sur platine Haken zum aufschrauben	p. 49		FG311	Column shoe with rebar - T type Balkenvoet met betonijzer - T type Pied de poteau avec fer de béton - Forme T Pfostensträger mit Riffeldolle - Form T	p. 58
	FG256	Pintle for concrete Betondium Gond à bétonner Haken zum betonieren	p. 50		FG312	Column shoe with rebar - U type Balkenvoet met betonijzer - U type Pied de poteau avec fer de béton - Forme U Pfostensträger mit Riffeldolle - Form U	p. 58
	FG257	Pintle for bricklaying Klauwdium voor baksteen Gond à maçonner Haken zum einmauern	p. 51		FG313	Pergola support with rebar Pergolasteun met betonijzer Support de Pergola avec fer pour béton Pergola-Unterstützung mit Dolle	p. 58
	FG258	Lag screw pintle Schroefduim Gond à vis à bois Haken zum einschrauben	p. 52		FG316	Column shoe with anchoring pl. - U type Balkenvoet met bevestigingspl. - U type Pied de poteau avec patte de fix. - Forme U Pfostensträger zum aufdübeln - Form U	p. 59
	FG259	Safety pintle Veiligheidsstift Axe infraudable Sicherungsstift	p. 53		FG317	Column shoe - U type Balkenv. met opschroefb. steun - U type Support de poutre - Forme U Pfostenträger U mit Balkenauflage	p. 59
	FG260	Plate pintle - Rustica Plaatduim - Rustica Gond sur platine - Rustica Haken zum aufschrauben - Rustica	p. 54		FG319	Fence holder - L type Vlechtschermsteun vorm "L" (los) Support panneau tresse - Forme L Flechtzaunbeschlag - Form L	p. 59
	FG265	Adjustable hinge - Black Verstelbaar heng - zwart Penture réglable - noire Ladenband verstellbar - schwarz	p. 54		FG320	Pointed pole anchor Paalhouder met punt Pied de poteau de jardin pointu Pfostensträger Rakete	p. 60
	FG300	Cross hinge - Light version Kruisheng - Licht type Penture en croix - Forme Légère Kreuzgehänge - leicht	p. 54		FG321	Post holder with anchor plate Paalhouder op plaat Pied de poteau avec patte d'ancrage Pfostensträger mit Grundplatte	p. 60
	FG301	Cross hinge - Heavy duty type Kruisheng - Zwaar type Penture en croix - Forme lourde Kreuzgehänge - schwer	p. 55		FG322	Hight adjustable post holder - P type Paalhouder verstelbare hoogte - P type Pied de poteau ajust. en hauteur - Forme P Pfostenträger Höhenverstellung - Typ P	p. 60
	FG302	T-Hinge T-Heng Penture anglaise T-Gehänge	p. 55		FG324	Fence holder combi Vlechtschermsteun combi Support panneau tresse combi Flechtzaunbeschlag combi	p. 61

Product Index

	FG325	Fence holder - L type Vlechtschermscherm vorm "L" (los) Support panneau tresse - Forme L Flechtzaunbeschlag - Form L	p. 61		FG344	Gate latch automatic Heksluiting automatisch Fermeture porte de jardin automatique Gartentorfaller automatisch	p. 68
	FG326	Fence holder - U type Vlechtschermscherm vorm "U" Support panneau tresse - Forme U Flechtzaunbeschlag - Form U	p. 63		FG345	Gate latch Hekklank Fermeture barrière Gartentorfaller	p. 68
	FG327	Bracket for panel fencing Draadpaneelklem Fixation treillis Befestigungsschele	p. 63		FG348	Kick-over latch Luikoverslag Fermeture de volet Schlagladenüberwurf	p. 69
	FG328	Column shoe - Adj. in height and width Verstelbare voet - in hoogte en breedte Pied de poteau - régl. en hauteur et largeur Pfostenstr. - höhen- und seitenverstellb.	p. 63		FG349	Shutter catch "shepherdress" wood thread Herderinnekopje met houtdraad Arrêt tête bergère à vis à bois Fensterlade-Feststeller mit Holzgewinde	p. 70
	FG329	Pole cover - Pyramid type Paalkap - piramidevormig Ornement de poteau - Forme pyramide Pfostenkappe - Pyramideförmig	p. 64		FG351	Barrel bolt Baionetgrendel Verrou à baionette Bolzenstangenriegel	p. 70
	FG330	Pole cover - Ball type Paalkap - bolvormig Ornement de poteau - Forme boule Pfostenkappe - Kugelförmig	p. 64		FG352	Slide bolt - American type Amerikaanse grendel Verrou à glissière - Forme Américaine Grendelriegel - Amerikanische Form	p. 71
	FG331	Plane sliding latch - Light version Vlakke schuif - Licht type Verrou de fenetre plat - Forme légère Fensterriegel gerade	p. 65		FG353	Slide bolt Plaatgrendel Verrou à glissière Grendelriegel	p. 71
	FG332	Plane window sliding latch Vlakke raamschuif Verrou pêne plat bouton Schlossriegel gerade	p. 65		FG354	Slide bolt for padlock Hangslotgrendel met oogslot achteraan Verrou à porte-cadenas Grendelriegel - abschliessbar	p. 72
	FG333	Plane roll latch Vlakke deurrolschuif Verrou à coulisse Rollen-Schlossriegel gerade	p. 66		FG355	Slide bolt for padlock Hangslotgrendel Verrou à porte-cadenas Grendelriegel - abschliessbar	p. 72
	FG334	Flat padlock sliding bolt Vlakke hangslotrolschuif Verrou pour cadenas à rouleau plat Rollenschlossriegel flach	p. 66		FG356	Slide bolt for padlock Hangslotgrendel Verrou à porte-cadenas Grendelriegel - abschliessbar	p. 73
	FG336	Plane latch for padlock Vlakke hangslotschuif Verrou à porte-cadenas plat Schlossriegel gerade	p. 66		FG357	Security bolt for pig stable Varkenshok veiligheidsgrendel Verrou d'étable de sécurité Sicherheitsstallriegel	p. 73
	FG340	Spagnolet with bolt loop Draaikrukschuif met veer Tarquette pêne plat Drehriegel mit Schlaufen	p. 67		FG358	Pistol latch Pistoolgrendel Verrou pistolet Pistolriegel	p. 73
	FG341	Farmer gate latch Boerenklankstel met inslagneus Fermeture à l'ancienne Gartentorfaller mit Einschlagneus	p. 67		FG380	Shelf bracket - Heavy type Plankendrager met steun - Zwaar type Support de table - Lourd Konsolenstutze - schwer	p. 76
	FG343	Garden gate latch Tuinheksluiting Fermeture porte de jardin Gartentorfaller	p. 68		FG381	Shelf bracket without support Plankendrager zonder steun Console sans support Konsolle ungestützt	p. 76

Product Index

	FG382	Pressed shelf bracket - Type 1 Geperste plankendrager - Type 1 Console emboutie - Type 1 Blechkonsole - Typ 1	p. 77		FG531	Window frame anchor wood thread Kozijnanker met houtdraad Fixation de chambranle filet bois Zargenanker mit Holzgewinde	p. 85
	FG383	Pressed shelf bracket - Type 2 Geperste plankendrager - Type 2 Console emboutie - Type 2 Blechkonsole - Typ 2	p. 77		FG534	Frame anchor - l + r Lijmkozijnanker - l + r Ancre chambranle à coller - g + d Zargenanker zum verkleben - l + r	p. 86
	FG384	Ornamental shelf bracket Ornamentale plankendrager Console ornamental Konsole ornamental	p. 78		FG563	Rim shuttering anchor Randbekistingsanker Ancrage pour margelle Randschalungsanker	p. 86
	FG385	Shelf bracket Plankendrager Console Konsole	p. 78		FG586	Wall anchor plate centre Muurplaatanker plaat centrisch Tirant de mur plaque centrée Steinanker platte zentrisch	p. 86
	FG388	Foldable shelf bracket Inklapbare plankendrager Console pliable Konsole klappbar	p. 79		FG599	Storm anchor Stormanker Ancrage tempête Windsoganker	p. 87
	FG413	Timber connector - Double sided Kramplaat - Dubbelzijdig getand Crampon - Double denture Holzverbinder - Dorne zweiseitig	p. 79		FG601	Storm anchorage Opwaaianker Ancrage tempête Windsoganker	p. 87
	FG421	Rolled knuckle hinge - Straight corners Gerolde knopscharnier - Rechte hoeken Charnière à noeud - Angle droite 90° Stangenscharnier gerollt - Winkel 90°	p. 80		FG606	Cramp iron Bintanker Ancrage bois/maçonnerie Balkenanker	p. 87
	FG422	Rolled hinge - Round corners and head Gerolde scharnier - Ronde hoeken en bolkop Charnière roulee - Angle arrondi et tête ronde Gerolde scharn. - Hecke abger. und Rundkopf	p. 80		FG651	Thin joint tie Prikspouwanker Crochet mur creux à coller Prik-Luftschtichtanker	p. 88
	FG423	Rolled knuckle hinge - Straight corners-plug Gerolde knopsch. - Rechte hoeken en vaaskop Charn. à noeuds roulee - Angle 90°-vase Stangenscharnier gerollt - Winkel 90°-stopfen	p. 81		FG661	Universal wall tie - L type Universeel L-spouwanker Crochet mur en L universel Universal L-Luftschtichtanker	p. 88
	FG424	Rolled knuckle hinge - Rounded corners-plug Gerolde knopsch. - Ronde hoeken en vaaskop Charn. à noeuds roulee - Angl. arrondis-vase Stangenscharn. gerollt - Winkel abger.-stopfen	p. 81		FG663	Wall tie - Mono Spouwanker - Mono Crochet mur - Mono Luftschtichtanker - Mono	p. 88
	FG517	Wall junction strip Lijmkoppelstrip Raccord à coller Mauerverbinder	p. 84		FG664	Wall tie with wood thread - L type L-spouwanker met houtdraad Crochet mur à filet bois - Forme L Luftschtichtanker mit Holzgewinde - Form L	p. 89
	FG521	Flexible wall clamp Uizetbaar wandanker Ancrage mur dilatant Wandanker beweglich	p. 84		FG671	Selftapping wall tie Slagspouwanker Crochet mur creux à clouer Dübelanker mit Einschlaggewinde	p. 89
	FG523	Spring anchor Veeranker Ancrage dilatant Federanker	p. 85				
	FG526	Slip tie Glijanker Tige de dilatation lisse Gleitanker	p. 85				

Product Index



Wood connectors

Houtverbindingen

Connecteurs bois

Holzverbindungen

Wood connectors

Houtverbindingen

Connecteurs bois

Holzverbindungen

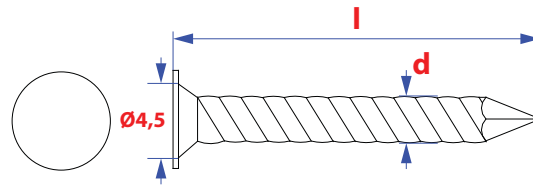

FG100

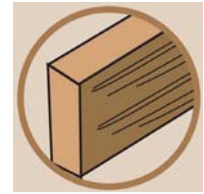

Schroefnagel - Ronde platte kop

Screw nails - Flat conical head

Pointes torsadées - Tête platte conique

Schraubennagel - Flachkopf-kegel



Art. Nr.	EAN Code	d [mm]	l [mm]	
FG0100001380325	5410439341783	3,8	32	200
FG0100001380605	5410439341790	3,8	60	200

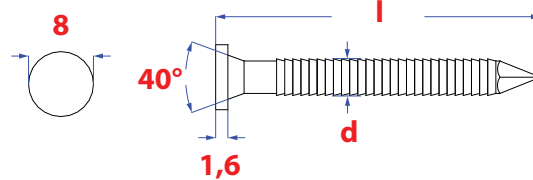

FG101



Ringnagels

Barbed nails

Pointes annelées

Rillennägel



Art. Nr.	EAN Code	d [mm]	l [mm]	
FG0101001400405	5410439343350	4	40	200
FG0101001400505	5410439343367	4	50	200
FG0101001400605	5410439343374	4	60	200

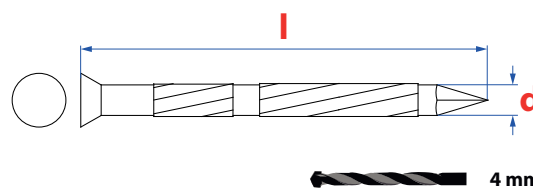

FG102

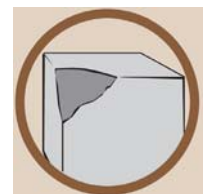

Klisjesnagel

Clamp nails

Pointes pour tasseaux

Klisjesnagel



Art. Nr.	EAN Code	d [mm]	l [mm]	Drill ø [mm]	
FG0102001450405	5410439344241	4,5	40	4	125
FG0102001450505	5410439344258	4,5	50	4	125

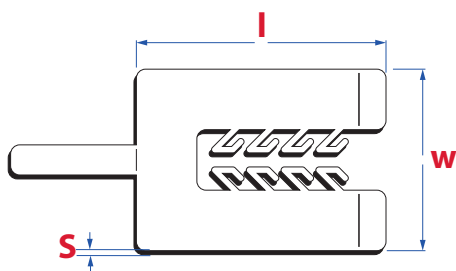

FG111

HAPAX Uitvulplaatjes

HAPAX Cales bardages

HAPAX Adjustment blocks

HAPAX Justierklotz



Art. Nr.	EAN Code	s [mm]	l [mm]	w [mm]	Colour	
FG01115000140555	5410439479509	1	55	50		25
FG01115000240555	5410439479516	2	55	50		25
FG01115000340555	5410439479523	3	55	50		25
FG01115000440555	5410439479530	4	55	50		25
FG01115000540555	5410439479547	5	55	50		25

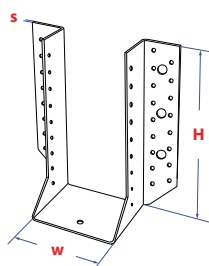

FG121

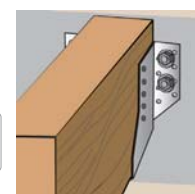

DoPn° FG121001

Zware balkendr. - Type A uitw. lippen

Support poutre - Forme A extérieures

Joist hanger - Type A exterior lip

Balkenschuh - Form A aussen abgewink.



Art. Nr.	EAN Code	w [mm]	H [mm]	s [mm]	Hole pattern Dia. of the hole/nr. of holes	
FG01210010251175*	5410439336963	25	117	2	Ø5/22 - Ø7/1 - Ø11/4	10
FG01210010321145*	5410439336994	32	114	2	Ø5/22 - Ø7/1 - Ø11/4	10
FG01210010401105*	5410439322799	40	110	2	Ø5/22 - Ø7/1 - Ø11/4	10
FG01210010401485	5410439359917	40	148	2	Ø5/28 - Ø7/1 - Ø9/4 - Ø13/4	10
FG01210010461025	5410439385343	46	102	2	Ø5/18 - Ø7/1 - Ø11/4	10
FG01210010461445	5410439390514	46	144	2	Ø5/30 - Ø7/1 - Ø9/4 - Ø14/4	10
FG01210010501055*	5410439322812	50	105	2	Ø5/22 - Ø7/1 - Ø11/4	10
FG01210010501435	5410439359870	50	143	2	Ø5/30 - Ø7/1 - Ø9/4 - Ø14/4	10
FG01210010591005*	5410439322836	59	100	2	Ø5/28 - Ø7/1 - Ø11/4	10
FG01210010591385*	5410439359894	60	130	2	Ø5/28 - Ø7/1 - Ø11/4	10
FG01210010591605	5410439322850	59	160	2	Ø5/34 - Ø7/1 - Ø9/4 - Ø13/4	10
FG01210010591905	5410439337021	59	190	2	Ø5/40 - Ø7/1 - Ø11/4	10
FG01210010630985*	5410439322874	63	98	2	Ø5/22 - Ø7/1 - Ø11/4	10
FG01210010631285*	5410439322898	63	128	2	Ø5/28 - Ø7/1 - Ø11/4	10
FG01210010631585*	5410439322911	63	158	2	Ø5/34 - Ø7/1 - Ø11/4	10
FG01210010631885	5410439337052	63	188	2	Ø5/44 - Ø7/1 - Ø9/4 - Ø13/6	10
FG01210010710955*	5410439337083	71	95	2	Ø5/22 - Ø7/1 - Ø11/4	10
FG01210010711255*	5410439337113	71	125	2	Ø5/28 - Ø7/1 - Ø11/4	10
FG01210010711545	5410439337144	71	154	2	Ø5/34 - Ø7/1 - Ø9/4 - Ø13/4	10

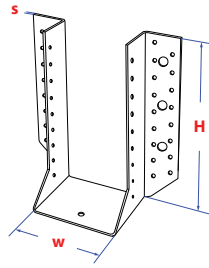

FG121



DoPn° FG121001

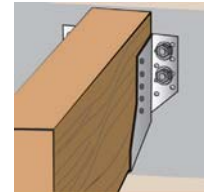

Zware balkendr. - Type A uitw. lippen
Support poutre - Forme A extérieures

Joist hanger - Type A exterior lip
Balkenschuh - Form A aussen abgewink.



Art. Nr.	EAN Code	w [mm]	H [mm]	s [mm]	Hole pattern Dia. of the hole/nr. of holes	
FG01210010711845*	5410439337175	71	184	2	Ø5/22 - Ø7/1 - Ø11/4	10
FG01210010751225*	5410439322935	75	122	2	Ø5/28 - Ø7/1 - Ø11/4	10
FG01210010751525*	5410439322959	75	152	2	Ø5/34 - Ø7/1 - Ø11/4	10
FG01210010751825*	5410439322973	75	182	2	Ø5/22 - Ø7/1 - Ø11/4	10
FG01210010752125*	5410439322997	75	212	2	Ø5/22 - Ø7/1 - Ø11/4	10
FG01210011001405*	5410439337205	100	140	2	Ø5/22 - Ø7/1 - Ø11/4	10
FG01210011002005	5410439034982	100	200	2	-	10
FG01210011201605*	5410439337236	120	160	2	Ø5/22 - Ø7/1 - Ø11/4	10

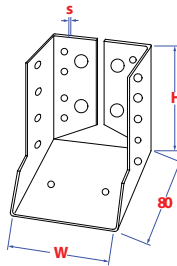

FG122



DoPn° FG122001

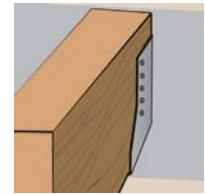

Zware balkendrager inwendige lippen
Sabots à ailes intérieures

Joist hanger - Inner folded
Balkenschuh nach innen abgewinkelt



Art. Nr.	EAN Code	w [mm]	H [mm]	s [mm]	Hole pattern Dia. of the hole/nr. of holes	
FG01220010601005*	5410439343206	60	100	2	Ø5/8 - Ø13/4 - Ø5/8	25
FG01220010801205*	5410439343220	80	120	2	Ø5/18 - Ø13/4 - Ø5/10	20

TYPE 260

Holes : $\varnothing 5 \times 22 - 7 \times 1 - 11 \times 4$

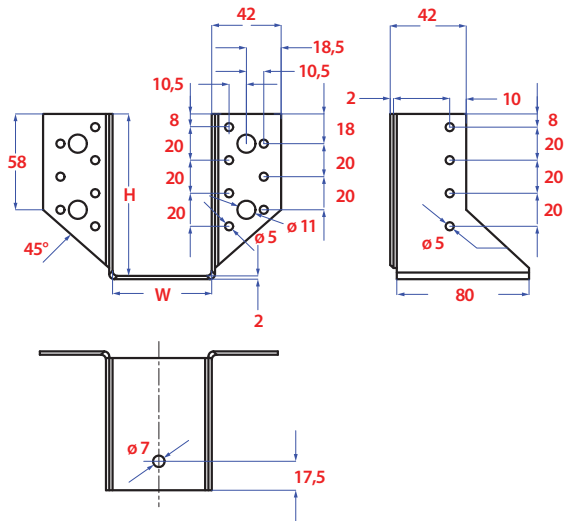

TYPE 320

Holes : $\varnothing 5 \times 28 - 7 \times 1 - 11 \times 4$

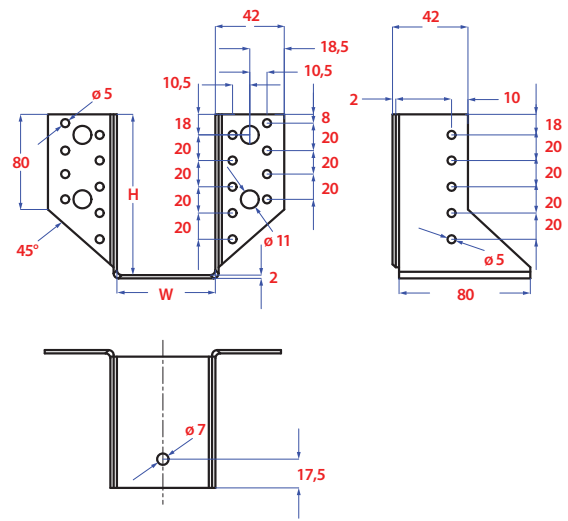

TYPE 380

Holes : $\varnothing 5 \times 35 - 7 \times 1 - 11 \times 4$

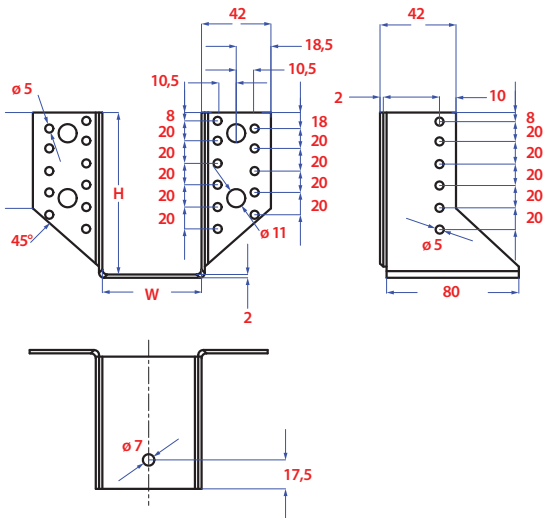

TYPE 440

Holes : $\varnothing 5 \times 40 - 7 \times 1 - 11 \times 4$

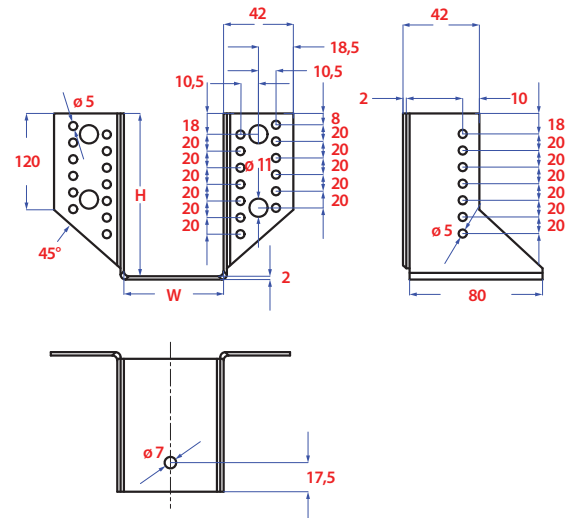

TYPE 500

Holes : $\varnothing 5 \times 48 - 7 \times 1 - 11 \times 6$

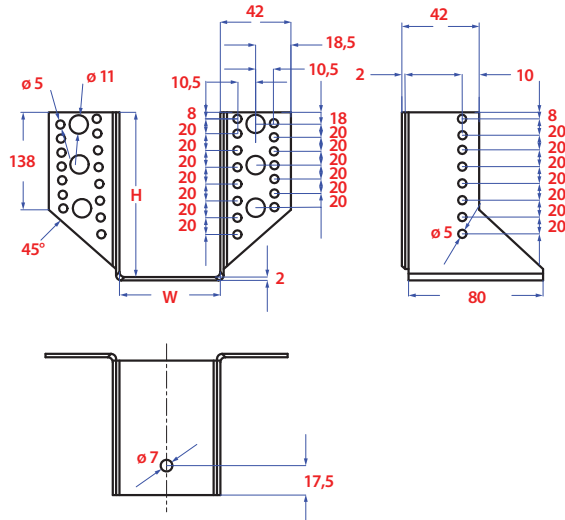

**Fixings - Bevestigingen
Fixations - Befestigungen**



TYPE : PETTG



TYPE : DIN 571



TYPE : SMK

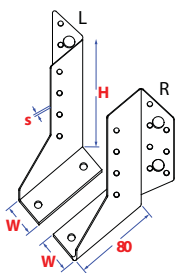

FG123

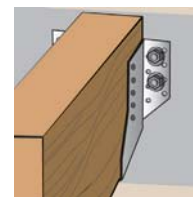

Zware balkendr. - 2-delig (l + r)

Joist hanger - 2-parts (left + right)

Sabots - 2 éléments (gauche + droite)

Balkenschuh - 2-teilig (links + rechts)



Art. Nr.	EAN Code	w [mm]	H [mm]	s [mm]	Hole pattern Dia. of the hole/nr. of holes	
FG01230010301005	5410439343299	30	100	2	Ø5/11 - Ø11/2	25
FG01230010301405	5410439343312	30	150	2	Ø5/17 - Ø11/2	25

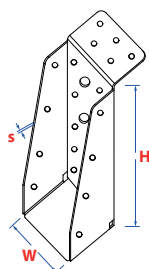

FG126

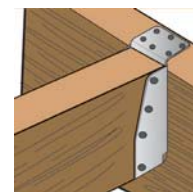

Balkdrager met lange lip

Beamsupport with long lip

Support de poutre avec lèvres longue

Balkenschuh mit lange Lasche



Art. Nr.	EAN Code	w [mm]	H [mm]	s [mm]	Hole pattern Dia. of the hole/nr. of holes	
FG01260010460965	5410439646628	46	96	1,5	Ø4/14 - Ø9/3 - Ø14/1	25
FG01260010461215	5410439336611	46	121	1,5	Ø4,3/14 - Ø8,7/2 - Ø13,8/1	25
FG01260010461465	5410439336635	46	146	1,5	Ø4,3/20 - Ø8,7/2 - Ø13,8/1	25
FG01260010501255	5410439336659	50	125	1,5	Ø4,3/14 - Ø8,7/2 - Ø13,8/1	25
FG01260010501505	5410439336673	50	150	1,5	Ø4,3/20 - Ø8,7/2 - Ø13,8/1	25
FG01260010591465	5410439390491	59	146	1,5	Ø4/20 - Ø9/3 - Ø14/1	25
FG01260010591565	5410439336697	59	156	1,5	Ø4,3/20 - Ø8,7/2 - Ø13,8/1	25
FG01260010591715	5410439336710	59	171	1,5	Ø4/20 - Ø9/3 - Ø14/1	25
FG01260010631605	5410439336734	63	160	1,5	Ø4,3/20 - Ø8,7/2 - Ø13,8/1	25
FG01260010631755	5410439321808	63	175	1,5	Ø4,3/20 - Ø8,7/2 - Ø13,8/1	25
FG01260010711715	5410439336758	71	171	1,5	Ø4,3/23 - Ø8,7/2 - Ø13,8/2	25
FG01260010711965	5410439336772	71	196	1,5	Ø4,3/23 - Ø8,7/2 - Ø13,8/2	25
FG01260010712215	5410439336796	71	221	1,5	Ø4,3/27 - Ø8,7/2 - Ø13,8/2	25
FG01260010751755	5410439336819	75	175	1,5	Ø4,3/23 - Ø8,7/2 - Ø13,8/2	25
FG01260010752005	5410439336833	75	200	1,5	Ø4,3/23 - Ø8,7/2 - Ø13,8/2	25
FG01260010752255	5410439336857	75	225	1,5	Ø4,3/27 - Ø8,7/2 - Ø13,8/2	25
FG01260010961965	5410439646642	96	196	1,5	Ø4/23 - Ø9/2 - Ø14/2	20
FG01260011002505	5410439336871	100	250	1,5	Ø4/25 - Ø9/2 - Ø14/2	10



Balkdrager zonder lip

Support de poutre sans lèvre

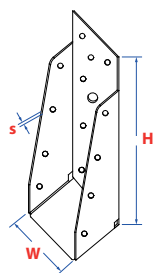

Beamsupport without lip

Balkenschuh ohne Lasche

FG128

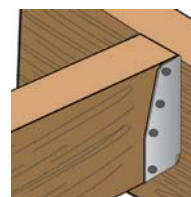

Art. Nr.	EAN Code	w [mm]	H [mm]	s [mm]	Hole pattern Dia. of the hole/nr. of holes	
FG01280010460965	5410439356985	46	96	1,5	Ø4/9 - Ø9/2 - Ø14/1	20
FG01280010461215	5410439355919	46	121	1,5	Ø4/11 - Ø9/2 - Ø14/1	20
FG01280010461465	5410439357005	46	146	1,5	Ø4/13 - Ø9/2 - Ø14/1	20
FG01280010501005	5410439357203	50	100	1,5	Ø4/9 - Ø9/2 - Ø14/1	20
FG01280010501505	5410439357470	50	150	1,5	Ø4/13 - Ø9/2 - Ø14/1	20
FG01280010591215	5410439357494	59	121	1,5	Ø4/12 - Ø9/2 - Ø14/1	20
FG01280010591465	5410439357524	59	146	1,5	Ø4/15 - Ø9/2 - Ø14/1	20
FG01280010591565	5410439357579	59	156	1,5	Ø4/14 - Ø9/2 - Ø14/1	20
FG01280010591715	5410439357593	59	171	1,5	Ø4/17 - Ø9/2 - Ø14/1	20
FG01280010631605	5410439357654	63	160	1,5	Ø4/14 - Ø9/2 - Ø14/1	20
FG01280010711715	5410439357685	71	171	1,5	Ø4/16 - Ø9/2 - Ø14/1	20
FG01280010711965	5410439357708	71	196	1,5	Ø4/20 - Ø9/2 - Ø14/2	20
FG01280010712215	5410439357722	71	221	1,5	Ø4/20 - Ø9/2 - Ø14/2	20
FG01280010752005	5410439355933	75	200	1,5	Ø4/20 - Ø9/2 - Ø14/2	20

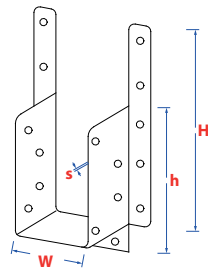

FG136

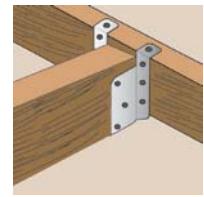

Raveeldrager met strip

Joist hanger with strap

Support poutre à lèvres à plier

Pfettenverbinder



Art. Nr.	EAN Code	w [mm]	h [mm]	s [mm]	H [mm]	Hole pattern Dia. of the hole/nr. of holes	
FG01360010321255	5410439321648	32	125	1	190	Ø4/18	50
FG01360010321585	5410439336406	32	158	1	225	Ø3,6/22	50
FG01360010381215	5410439321662	38	121	1	190	Ø3,6/20	50
FG01360010381555	5410439336420	38	155	1	225	Ø3,6/22	50
FG01360010461175	5410439321686	46	117	1	190	Ø3,6/20	50
FG01360010461535	5410439336444	46	153	1	225	Ø3,6/22	50
FG01360010501155	5410439336475	50	115	1	190	Ø3,6/20	50
FG01360010501505	5410439336499	50	150	1	225	Ø3,6/22	50
FG01360010591105	5410439336512	59	110	1	190	Ø3,6/20	50
FG01360010591535	5410439336536	59	153	1	225	Ø3,6/22	50
FG01360010631555	5410439336574	63	155	1	225	Ø3,6/22	50
FG01360010711155	5410439646666	71	115	1	190	Ø3,6/20	100
FG01360010711525	5410439646680	71	152	1	225	Ø3,6/22	50
FG01360010751495	5410439336598	75	149	1	305	Ø4/30	50

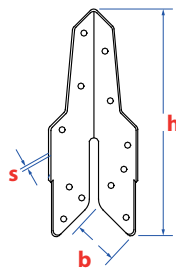

FG141

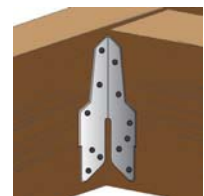

Universeel hoek gripanker

Universal coner joint

Patte-equerre d'ancrage mod. universel

Eckverbinder universal



Art. Nr.	EAN Code	b [mm]	h [mm]	s [mm]	Hole pattern Dia. of the hole/nr. of holes	
FG01410010000055	5410439341745	35	125	1,2	Ø3,7/12	50

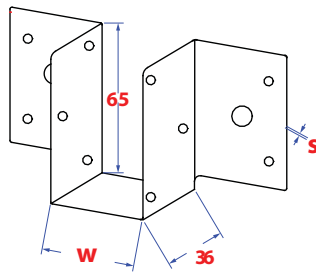

FG142

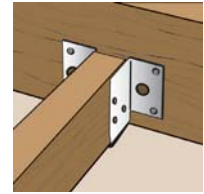

Regeldrager - Type "U"

Light joist hanger - "U" Type

Support de poutre - Forme "U"

Balkenschuh - Typ "U"



Art. Nr.	EAN Code	w [mm]	s [mm]	Hole pattern Dia. of the hole/nr. of holes	
FG01420010000255	5410439321709	25	1	Ø3,6/10 - Ø6,2/2	10
FG01420010000325	5410439321723	32	1	Ø4/12 - Ø9/2	10
FG01420010000385	5410439321747	38	1	Ø3,6/10 - Ø6,2/2	10
FG01420010000465	5410439321761	46	1	Ø3,6/10 - Ø6,2/2	10
FG01420010000505	5410439321785	50	1	Ø3,6/10 - Ø6,2/2	10
FG01420010000595	5410439390484	59	1	Ø3,6/10 - Ø6,2/2	10
FG01420010000635	5410439359481	63	1,25	Ø3,6/10 - Ø6,2/2	10

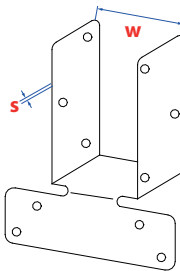

FG144



Trussclip - verticaal

Truss clip - vertical

Pied de fermette - Verticalement

Balkenverbinder - Vertikal



Art. Nr.	EAN Code	w [mm]	s [mm]	Hole pattern Dia. of the hole/nr. of holes	
FG01440010000465	5410439342278	46	1,25	Ø3,6/10	25
FG01440010000505	5410439342292	50	1,25	Ø3,6/10	25
FG01440010000595	5410439342315	59	1,25	Ø4/10	25



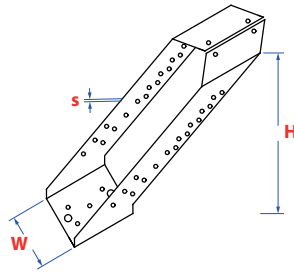

Gordinglas
Cantilever

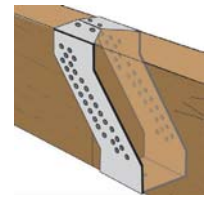

Purlin joint
Balkenverbinder

FG151



Art. Nr.	EAN Code	w [mm]	H [mm]	s [mm]	Hole pattern Dia. of the hole/nr. of holes	
FG01510010631755	5410439341806	63	175	1,5	Ø4/41 - Ø8/2	10
FG01510010752005	5410439341813	75	200	1,5	Ø4/49 - Ø8/2	10



Verbindingshoek - links + rechts
Pattes de solivage - gauche + droite

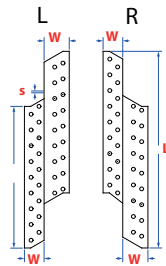

Roof ridge fixing - left + right
Sparrenpfettenanker - Links + Rechts

FG153

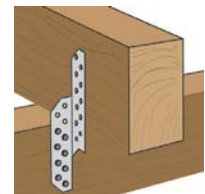

DoPn° FG153001



Art. Nr.	EAN Code	w [mm]	L [mm]	s [mm]	Hole pattern Dia. of the hole/nr. of holes	
FG015300132170L5*	5410439342889	32	170	2	Ø5/20	100
FG015300132170R5*	5410439342865	32	170	2	Ø5/20	100
FG015300132210L5*	5410439342926	32	210	2	Ø5/28	100
FG015300132210R5*	5410439342902	32	210	2	Ø5/28	100
FG015300132250L5*	5410439342933	32	250	2	Ø5/20	100
FG015300132250R5*	5410439342957	32	250	2	Ø5/32	100
FG015300132290L5*	5410439390682	32	290	2	-	100
FG015300132290R5*	5410439390705	32	290	2	-	100



Gordingklos
Echantignoles

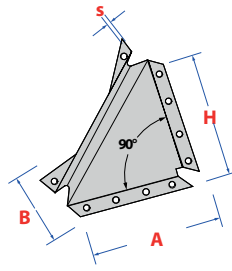

Chocks
Knaggen

FG154



Art. Nr.	EAN Code	A [mm]	B [mm]	s [mm]	h [mm]	Hole pattern Dia. of the hole/nr. of holes	
FG01540010900755	5410439345699	90	75	2	90	Ø5/16	20
FG01540011300755	5410439345712	130	75	2	130	Ø5/20	20



Hoekverbinder - Type A
Patte de solivage - Typ A

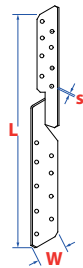

Roof ridge fixing - "A" Type
Sparrenpfettenanker - Typ "A"



DoPn° FG155001



Art. Nr.	EAN Code	w [mm]	l [mm]	s [mm]	
FG01550010351705*	5410439361521	35	170	2	100

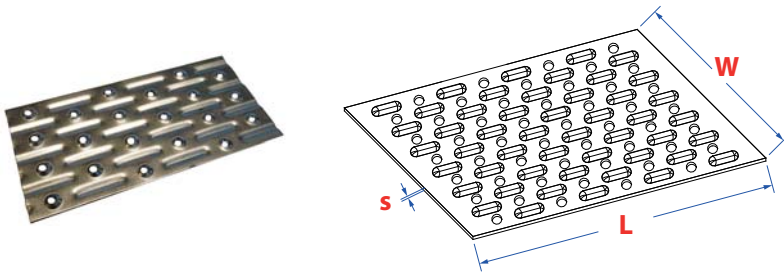

Spijkerplaat
Plaque à clouer

Nailing gusset
Lochplatte

FG156

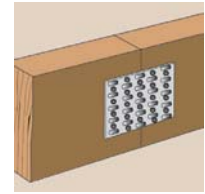

Art. Nr.	EAN Code	w [mm]	L [mm]	s [mm]	Hole pattern Dia. of the hole/nr. of holes	
FG01560010750505	5410439359566	75	50	1,25	-	100
FG01560010751005	5410439027168	75	100	1	Ø3,6/21	100
FG01560010752005	5410439337298	75	200	1	-	50
FG01560010752505	5410439337311	75	250	1,25	Ø3,6/35	50
FG01560010753005	5410439337335	75	300	1,25	Ø3,6/42	25
FG01560011060505	5410439337373	106	50	1,25	-	100
FG01560011061005	5410439337366	106	100	1,25	-	50
FG01560011061505	5410439337359	106	150	1,25	-	50
FG01560011062005	5410439321587	106	200	1,25	Ø3,6 /40	25
FG01560011062505	5410439337342	106	250	1,25	Ø3,6/50	25

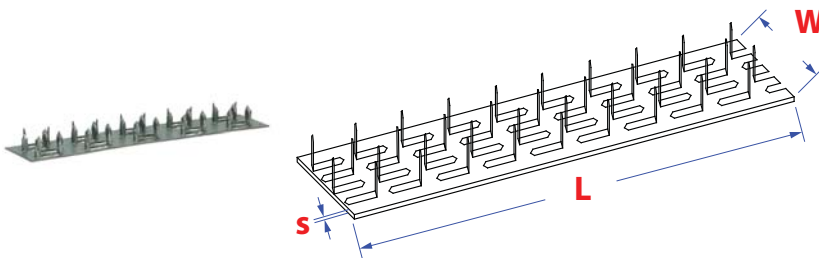

Multi-nagelplaat
Platinne à clous

Multinailing gusset
Nagelplatte

FG158

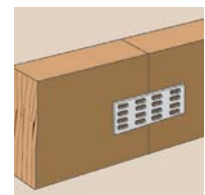

Art. Nr.	EAN Code	w [mm]	L [mm]	s [mm]	
FG01580010250995	5410439321600	25	99	1	50
FG01580010251305	5410439321624	25	130	1	50
FG01580010252005	5410439336345	25	200	1	50
FG01580010761295	5410439336376	76	129	1	50

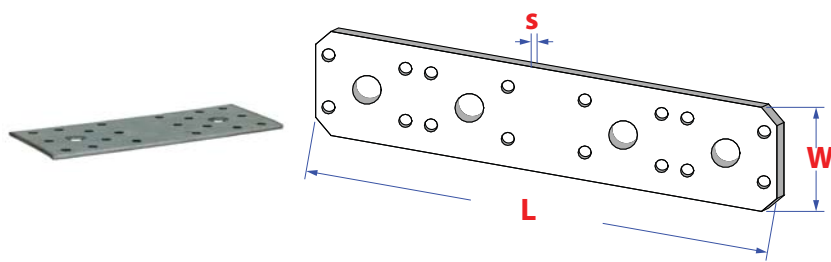

Koppelplaat - Zwaar type

Platine d'assemblage - Typ lourde

Flat connector - Heavy type

Flachverbinder - Schwer

FG159

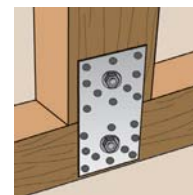

DoPn° FG159001



Art. Nr.	EAN Code	w [mm]	L [mm]	s [mm]	Hole pattern Dia. of the hole/nr. of holes	
FG01590010401005*	5410439322195	35	95	3	Ø5/8 - Ø11/2	100
FG01590010401805*	5410439322232	40	180	3	Ø5/16 - Ø11/4	50
FG01590010551405*	5410439322218	55	135	2,5	Ø5/20 - Ø13/2	50
FG01590010651765*	5410439322256	65	176	3	Ø5/20 - Ø13/2	50
FG01590010901955*	5410439322270	90	200	3	Ø5/32 - Ø13/4	50



Verbindingsplaat

Platine d'assemblage

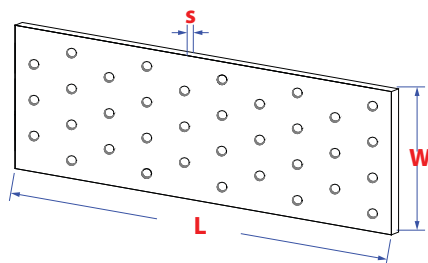

Anchor plate

Lochplatten

FG160

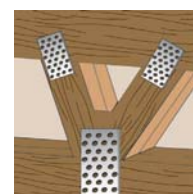

DoPn° FG160001



Art. Nr.	EAN Code	w [mm]	L [mm]	s [mm]	Hole pattern Dia. of the hole/nr. of holes	
FG01600010400605*	5410439322294	40	60	2	Ø5/6	200
FG01600010400805*	5410439359580	40	80	2	Ø5/8	100
FG01600010401005*	5410439359603	40	100	2	Ø5/10	100
FG01600010401205*	5410439322317	40	120	2	Ø5/12	100
FG01600010401605*	5410439363068	40	160	2	Ø5/16	100
FG01600010402005*	5410439363075	40	200	2	Ø5/20	100
FG01600010402405*	5410439322331	40	240	2	Ø5/23	100
FG01600010601405*	5410439322355	60	140	2	Ø5/21	50
FG01600010602005*	5410439322379	60	200	2	Ø5/30	50
FG01600010602405*	5410439322393	60	240	2	Ø5/36	50
FG01600010802005*	5410439322416	80	200	2	Ø5/40	50
FG01600010802405*	5410439322430	80	240	2	Ø5/48	50
FG01600010803005*	5410439359641	80	300	2	Ø5/60	25
FG01600011001405*	5410439363082	100	140	2	Ø5/35	50
FG01600011002005*	5410439359665	100	200	2	Ø5/50	25
FG01600011002405*	5410439359689	100	240	2	Ø5/60	50
FG01600011003005*	5410439363792	100	300	2	Ø5/75	25

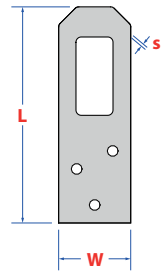

FG161

Kapstok ophangoog

Platine porte-manteau

Coat rack plate

Rahmenöse



Art. Nr.	EAN Code	w [mm]	L [mm]	s [mm]	Hole pattern Dia. of the hole/nr. of holes	
FG01610010200305	5410439337724	20	30	1,25	-	50
FG01610010200505	5410439337748	20	50	1,25	-	50
FG01610010200605	5410439337762	20	60	1,25	-	50

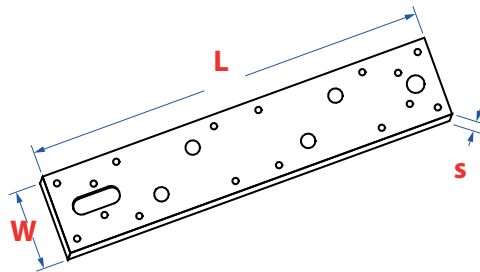

FG162



Koppelplaat

Plaque d'assemblage

Fish plate

Flachverbinder



Art. Nr.	EAN Code	w [mm]	L [mm]	s [mm]	Hole pattern Dia. of the hole/nr. of holes	
FG01620010462505	5410439360739	46	250	2,5	4,5/10-6,5/6-19,5/1-20X10,5/1	50
FG01620010552505	5410439360753	60	240	2,5	Ø4/12 - Ø6/8 - Ø11/2	50

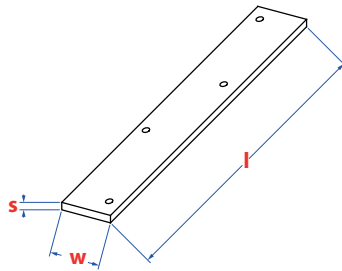

FG163

Koppelanker

Ancrage d'accouplement

Strap anchor

Flachverbinder



Art. Nr.	EAN Code	w [mm]	L [mm]	s [mm]	Hole pattern Dia. of the hole/nr. of holes	
FG01630010303005	5410439623957	30	300	5	Ø4/7	25
FG01630010304005	5410439623971	30	400	5	Ø6/7	25

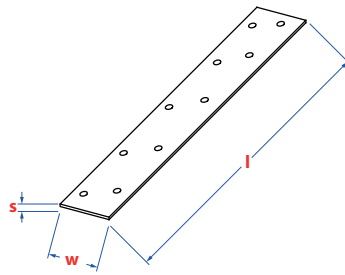

FG164

Koppelanker

Ancrage d'accouplement

Strap anchor

Flachverbinder



Art. Nr.	EAN Code	w [mm]	l [mm]	s [mm]	Hole pattern Dia. of the hole/nr. of holes	
FG01640010303005	5410439632263	30	300	2	Ø3,7/8	25
FG01640010304005	5410439632287	30	400	2	Ø4/12 - Ø9/2	25

FG166

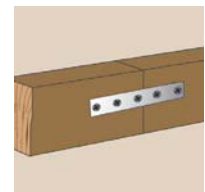
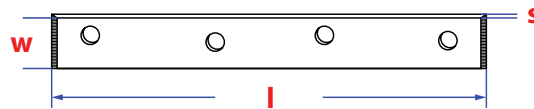

Verbindingsplaat - Smal type

Platine de connection - Type étroite

Connector - Narrow type

Verbindungsplatte - Schmal



Art. Nr.	EAN Code	w [mm]	l [mm]	s [mm]	Hole pattern Dia. of the hole/nr. of holes	
FG01660010150505	5410439322119	15	50	2	Ø4/4	100
FG01660010150705	5410439322133	15	80	2	Ø4/4	100
FG01660010161005	5410439322157	16	100	2	Ø4/4	50
FG01660010161255	5410439322171	18	120	2	Ø4/4	50
FG01660010181505	5410439336901	18	150	2	Ø5/4	50
FG01660010181755	5410439336925	18	175	2,5	Ø5/4	50
FG01660010192005	5410439336949	19	200	2,5	Ø5/4	50

FG166

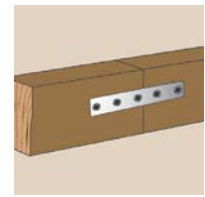
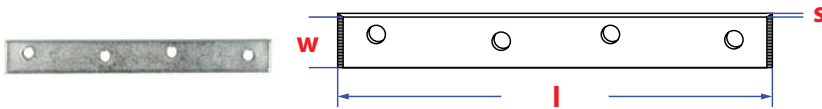

Verbindingsplaat - Smal type

Connector - Narrow type

Platine de connection - Type étroite

Verbindungsplatte - Schmal



Art. Nr.	EAN Code	w [mm]	l [mm]	s [mm]	Hole pattern Dia. of the hole/nr. of holes	
FG0166A000150755	5410439016384	15	75	2	Ø4,5/4	50
FG0166A000151005	5410439016414	15	100	2	Ø4,5/4	50
FG0166A000181205	5410439016438	18	120	2	Ø5,5/4	50

FG168

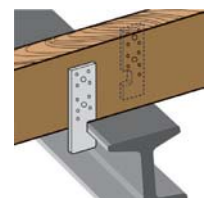
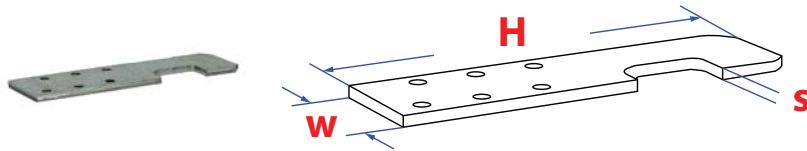

DoPn° FG168001

Verbindingsplaat - IPN/hout

T-anchor plate - Connecting IPN/wood

Ancrages IPN - Liaison IPN/bois

HE-anker T-träger/holzbalken



Art. Nr.	EAN Code	w [mm]	H [mm]	s [mm]	Hole pattern Dia. of the hole/nr. of holes	
FG01680010401355*	5410439343152	40	135	4	Ø5/6	100
FG01680010401755*	5410439343176	40	175	4	Ø5/10 - Ø13/2	50

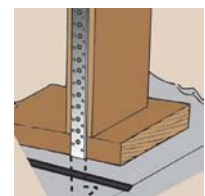
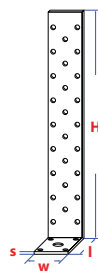

DoPn° FG169001

Betonanker

Anchor square

Equerre d'ancrage à sceller

Betonflachstahllanker



Art. Nr.	EAN Code	w [mm]	H [mm]	s [mm]	Hole pattern Dia. of the hole/nr. of holes	
FG01690010402005*	5410439342780	40	200	2	Ø5/19 - Ø12,3/1	25
FG01690010403005*	5410439342803	40	300	2	-	25
FG01690010404005*	5410439342827	40	400	2	-	25

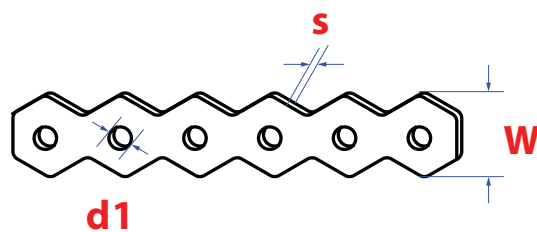

FG170



Gegolfde gaatjesb. in cassette - 10 m

Corrugated assembly belt/plast. box - 10 m

Bande perfo ondulée en cassette - 10 m

Windrispenband gewelld in cassette - 10 m



Art. Nr.	EAN Code	w [mm]	l [m]	s [mm]	d1 [mm]	Hole pattern Dia. of the hole/nr. of holes	
FG017000112085	5410439343404	12	10	0,8	5	Ø5	10
FG017000117085	5410439343411	17	10	0,8	7	Ø3 - Ø6,3	10
FG017000126105	5410439343435	26	10	1	8,5	Ø8,5	10

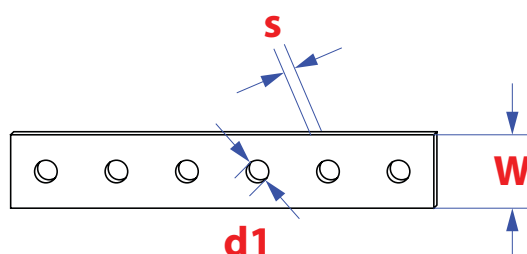

FG171



Rechte gaatjesb. in cassette - 10 m

Straight assembly belt/plastic box - 10 m

Bande perfo droite en cassette - 10 m

Windrispenband recht in cassette - 10 m



Art. Nr.	EAN Code	w [mm]	l [m]	s [mm]	d1 [mm]	Hole pattern Dia. of the hole/nr. of holes	
FG017100112085	5410439343466	12	10	0,8	5,3	Ø5,2	10
FG017100117085	5410439343480	17	10	0,8	6,5	Ø6,5	10
FG017100125105	5410439343503	25	10	1	8,5	Ø8,5	5

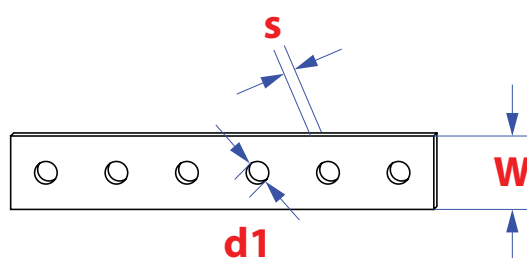

FG171



Rechte gaatjesb. in cassette - 10 m

Straight assembly belt/plastic box - 10 m

Bande perfo droite en cassette - 10 m

Windrispenband recht in cassette - 10 m



Art. Nr.	EAN Code	w [mm]	l [m]	s [mm]	d1 [mm]	Hole pattern Dia. of the hole/nr. of holes	
FG0171A0012085	5410439343541	12	10	0,8	5,3	Ø5,2	10
FG0171A0017085	5410439343527	17	10	0,8	6,5	Ø6,5	10



Rechte gaatjesband - 10 m

Bande perforée droite - 10 m

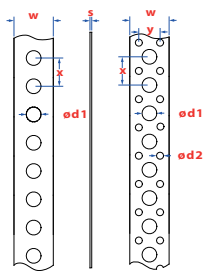

Straight assembly belt - 10 m

Windrispenband recht - 10 m

FG172



Art. Nr.	EAN Code	w [mm]	l [m]	s [mm]	d1 [mm]	d2 [mm]	Hole pattern Dia. of the hole/nr. of holes	
FG017200112085	5410439337267	12	10	0,8	5,2	-	Ø5,2	10
FG017200117085	5410439211949	17	10	0,8	6,5	3	Ø3 - Ø6,5	10
FG017200125105	5410439211956	25	10	1	8,5	4	Ø4 - Ø8,5	10



Rechte gaatjesband, geplastificeerd - 10 m

Bande perforée droite, plastifié - 10 m

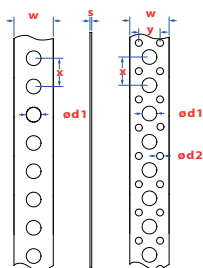

Straight assembly belt, plasticized - 10 m

Windrispenband recht, plastificiert - 10 m

FG172



Art. Nr.	EAN Code	w [mm]	l [m]	s2 [mm]	s [mm]	d1 [mm]	Hole pattern Dia. of the hole/nr. of holes	
FG017207414085	5410439343626	14	10	3	0,8	5,2	Ø5,2	10
FG017207419085	5410439343664	19	10	3	0,8	6,5	Ø6,5	10
FG017207427085	5410439343688	27	10	3	0,8	8,5	Ø8,5	5



Rechte gaatjesband - 10 m

Bande perforée droite - 10 m

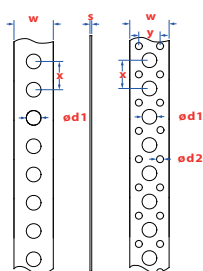

Straight assembly belt - 10 m

Windrispenband recht - 10 m

FG172



Art. Nr.	EAN Code	w [mm]	l [m]	s [mm]	d1 [mm]	d2 [mm]	Hole pattern Dia. of the hole/nr. of holes	
FG0172A0012085	5410439343602	12	10	0,8	5,3	-	Ø5,2	10
FG0172A0017085	5410439343589	17	10	0,8	6,5	-	Ø6,5	10
FG0172A0025085	5410439343565	25	10	0,8	8,5	-	Ø8,5	5



Rechte gaatjesband - 25 m

Bande perforée droite - 25 m

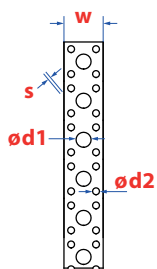

Straight assembly belt - 25 m

Windrispenband recht - 25 m

FG173



Art. Nr.	EAN Code	w [mm]	l [m]	s [mm]	d1 [mm]	d2 [mm]	Hole pattern Dia. of the hole/nr. of holes	
FG017300112085	5410439337281	12	25	0,8	5,3	3	Ø5,2	5
FG017300117085	5410439211970	17	25	0,8	6,5	3	Ø6,5	10
FG017300125105	5410439211987	25	25	1	8,5	3	Ø8,5	5



Beton hoekanker

Equerre de fixation béton

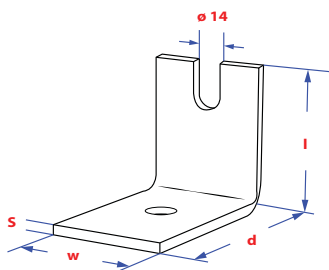

Angled lug

Betonwinkel

FG174



Art. Nr.	EAN Code	d [mm]	l [mm]	s [mm]	w [mm]	Hole pattern Dia. of the hole/nr. of holes	
FG01740100750755	5410439352246	75	75	6	60	Ø14/1	50
FG01740100751005	5410439352260	75	100	6	60	Ø14/1	25



Rechte gaatjesband - 5 m

Bande perforée droite - 5 m

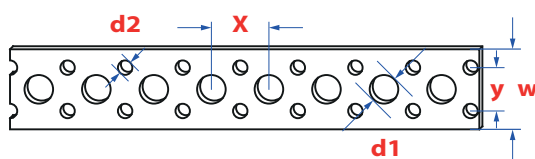

Straight assembly belt - 5 m

Windrispenband recht - 5 m

FG175



Art. Nr.	EAN Code	w [mm]	l [m]	s [mm]	d1 [mm]	d2 [mm]	Hole pattern Dia. of the hole/nr. of holes	
FG017500125105	5410439361545	25	5	1	8,5	3	Ø8,5	5

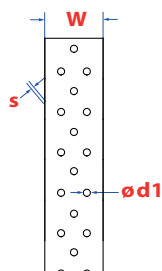

FG178

Rechte gaatjesband - 50 m

Straight assembly belt - 50 m

Bande perforée droite - 50 m

Windrispenband recht - 50 m



Art. Nr.	EAN Code	w [mm]	l [m]	s [mm]	Hole pattern Dia. of the hole/nr. of holes	
FG017800117085	5410439297189	17	50	0,8	Ø6,5	5

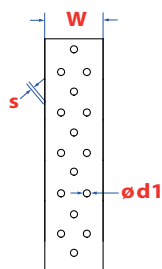

FG178

Rechte gaatjesband - 50 m

Straight assembly belt - 50 m

Bande perforée droite - 50 m

Windrispenband recht - 50 m



DoPn° FG178001



Art. Nr.	EAN Code	w [mm]	l [m]	s [mm]	d1 [mm]	Hole pattern Dia. of the hole/nr. of holes	
FG017801040205*	5410439339704	40	50	2	5	Ø5	1

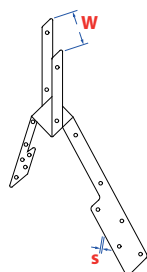

FG179

Ruitersteun

Ridge piece support

Cavalier rehausse pour charpente

Firstlattenhalter

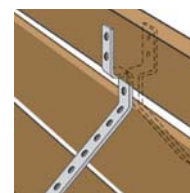

Art. Nr.	EAN Code	w [mm]	s [mm]	Hole pattern Dia. of the hole/nr. of holes	
FG01790010000285	5410439342148	28	1,5	Ø3,4/14	50
FG01790010000325	5410439342162	32	1,5	Ø3,4/14	50



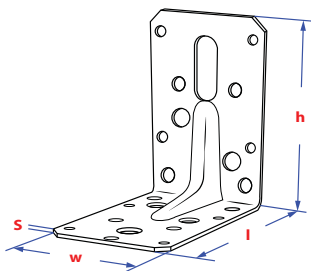

Verstelbaar hoekanker met ril
Equerre ajustable renforcé

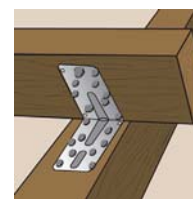

Reinforced adjustable square
Winkelverbinder abstelbar mit Sicke

FG185



Art. Nr.	EAN Code	w [mm]	l [mm]	s [mm]	h [mm]	Hole pattern Dia. of the hole/nr. of holes	
FG01850010600905	5410439390538	60	90	2	90	4,5/8-6/9-9/4-11/1-30X10,5/1	50
FG01850010601505	5410439390552	60	150	2,5	90	4,5/12-6,4/8-9/5-11/2-30X11/1	50



Hoekanker met ril en afgeschuinde hoeken
Equerre renforcé

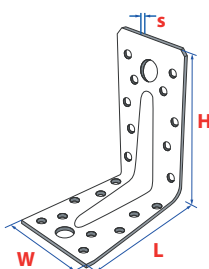

Reinforced square
Winkelverbinder mit Sicke

FG186



DoPn° FG186001



Art. Nr.	EAN Code	w [mm]	l [mm]	s [mm]	h [mm]	Hole pattern Dia. of the hole/nr. of holes	
FG01860011251255*	5410439321488	46	125	2,5	125	4,5/10-6,5/6-10,5/1-30X20/1	50
FG01860011501505*	5410439321501	60	150	2,5	150	4,5/20-6/4-9/4-30X11/2	50



Verstelbaar hoekanker
Equerre ajustable

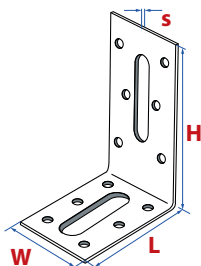

Adjustable square
Winkelverbinder mit Kombiloeh

FG187



DoPn° FG187001



Art. Nr.	EAN Code	w [mm]	l [mm]	s [mm]	h [mm]	Hole pattern Dia. of the hole/nr. of holes	
FG01870014612125*	5410439273121	46	125	2,5	125	Ø4/10 - Ø6/6 - Ø11/1	50
FG01870016040605	5410439321525	60	40	2,5	60	4,5/12-9/2-11/1-10,5X30/1	50
FG01870016050505	5410439321549	60	50	2,5	50	Ø4,5/12 - Ø11,5X30/2	50
FG01870016090905	5410439361118	60	90	2,5	90	4,1/8-6/9-9/4-11/1-30X11/1	50
FG01870016099405	5410439390576	60	100	2,5	40	Ø4,5/12 - Ø10/1 - Ø11X30/2	50
FG01870016315155	5410439361149	60	150	2,5	150	4,5/20-6/4-9/4-30X11/2	50



Hoekanker - Zwaar type
Equerre - Forme lourde

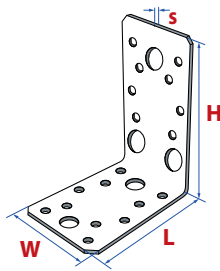

Square - Heavy type
Winkelverbinder - schwer

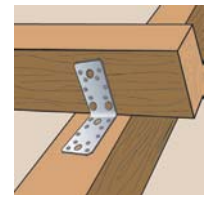

DoPn° FG188001

FG188

Art. Nr.	EAN Code	w [mm]	l [mm]	s [mm]	h [mm]	Hole pattern Dia. of the hole/nr. of holes	
FG01880010350505*	5410439322515	35	50	2,5	50	Ø5/8 - Ø10,4/2	150
FG01880010400905*	5410439322553	40	90	3	90	Ø5/16 - Ø11/4	50
FG01880010550705*	5410439322539	55	70	2,5	70	Ø5/12 - 11/2	50



Hoekanker met ril
Equerre renforcé - Forme lourde

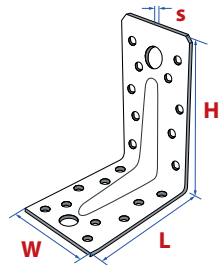

Heavy reinforced square
Winkelverbinder mit Verstärkungs-Sicke



DoPn° FG189001

FG189

Art. Nr.	EAN Code	w [mm]	l [mm]	s [mm]	h [mm]	Hole pattern Dia. of the hole/nr. of holes	
FG01890010550705*	5410439359528	55	70	2,5	70	Ø5/12 - Ø11/2	50
FG01890010650905*	5410439322577	65	90	2,5	90	Ø5/20 - Ø11/2	50
FG01890010901055*	5410439322591	90	105	3	105	Ø5/26 - Ø11/4	25



Hoekanker met ril
Equerre renforcé - Forme lourde

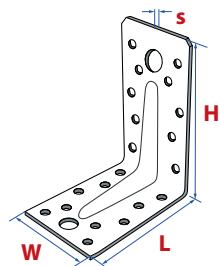

Heavy reinforced square
Winkelverbinder mit Verstärkungs-Sicke

FG189

Art. Nr.	EAN Code	w [mm]	l [mm]	s [mm]	h [mm]	Hole pattern Dia. of the hole/nr. of holes	
FG0189A000600905	5410439627436	60	90	2	90	Ø5/8 - Ø6/9 - Ø9/4 - Ø30X11/1	25

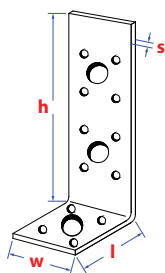

FG190



DoPn° FG190001



Hoekanker voor hout/beton

Anchor square for wood/concrete

Equerre d'ancrage pour bois/béton

Winkelverbinder holz/beton



Art. Nr.	EAN Code	w [mm]	h [mm]	s [mm]	
FG01900010400905*	5410439363280	40	90	2,5	100
FG01900010401605*	5410439352642	40	160	3	25

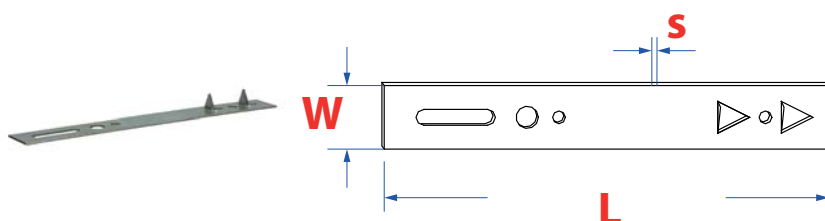

FG206

Raamklauw voor houten ramen

Mounting tabs for wooden frames

Pattes de fixation de fenêtres bois

Montagelaschen für Holzrahmen



Art. Nr.	EAN Code	w [mm]	l [mm]	s [mm]	
FG02060010191405	5410439343725	19	140	1,25	100
FG02060010251405	5410439343749	25	140	2	100

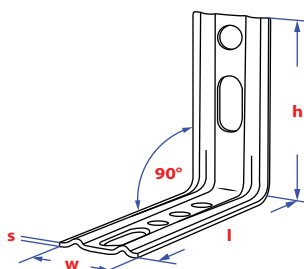

FG210



Kozijnhoek met ril - 90°

Multi angle bracket - 90°

Equerre nervurée droite - 90°

Winkel mit Rille - 90°



Art. Nr.	EAN Code	w [mm]	l [mm]	s [mm]	Hole pattern Dia. of the hole/nr. of holes	
FG02100010300905	5410439361378	30	90	2	Ø6,4/4 - Ø8,1/1 - Ø6,5X25/2	100



Stoelhoek
Equerre chaise

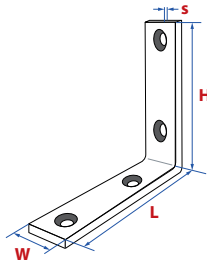

Narrow square
Stuhlwinkel

FG227



Art. Nr.	EAN Code	w [mm]	l [mm]	s [mm]	h [mm]	Hole pattern Dia. of the hole/nr. of holes	
FG02270010150205	5410439015639	14	20	2	20	Ø4/2	100
FG02270010150255	5410439273046	14	25	2	25	Ø4/4	100
FG02270010150305	5410439320474	14	30	2	30	Ø4/4	100
FG02270010150405	5410439321990	15	40	2	40	Ø4,5/4	100
FG02270010160505	5410439322010	15	50	2	50	Ø5/4	100
FG02270010160655	5410439322034	16	60	2	60	Ø5/4	100
FG02270010180755	5410439322058	17,5	75	2	75	Ø5,5/5	100
FG02270010190905	5410439273060	20	90	2	90	Ø5,5/6	100
FG02270010191005	5410439322072	20	100	2,25	100	Ø5,5/6	100
FG02270010201255	5410439322096	23	125	2,5	125	Ø5,5/6	100
FG02270010251505	5410439273084	25	150	3	150	Ø6,5/6	100



Stoelhoek
Equerre chaise

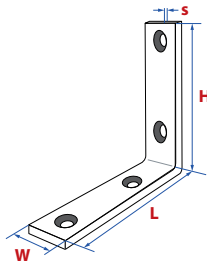

Narrow square
Stuhlwinkel

FG227



Art. Nr.	EAN Code	w [mm]	l [mm]	s [mm]	h [mm]	Hole pattern Dia. of the hole/nr. of holes	
FG0227A000150255	5410439016056	15	25	1,8	25	Ø4,5/4	100
FG0227A000150405	5410439361606	15	40	2	40	Ø4,5/4	100
FG0227A000150505	5410439016049	15	50	2	50	Ø4,5/4	100
FG0227A000200605	5410439361637	20	60	2	60	Ø5/4	50
FG0227A000200805	5410439361644	20	80	2	80	Ø5,5/4	50
FG0227A000201005	5410439361651	20	100	2	100	Ø5,5/6	50



Dorpelhoek - Zwaar type

Equerre porte - Forme lourde

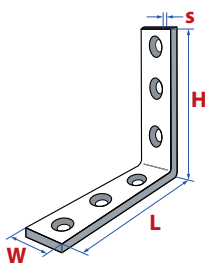

Narrow square - Heavy type

Winkelverbinder schwer

FG228



Art. Nr.	EAN Code	w [mm]	l [mm]	s [mm]	h [mm]	Hole pattern Dia. of the hole/nr. of holes	
FG02280010201005	5410439324243	20	100	5	100	Ø6/4	25
FG02280010201255	5410439324267	20	120	5	120	Ø6/6	25
FG02280010251505	5410439324281	20	160	5	160	Ø6/6	25
FG02280010251755	5410439324304	20	180	5	180	Ø6/6	25
FG02280010252005	5410439324328	25	200	5	200	Ø6/6	25
FG02280010302505	5410439324342	30	250	6	250	Ø6/6	25



Neusijzer - 135°

Equerre asymétrique - 135°

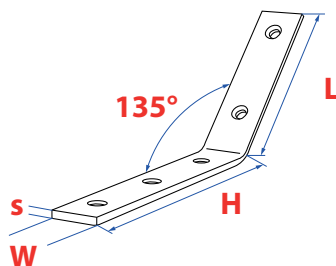

Reinforced corner skew - 135°

Winkelverbinder - 135°

FG230



Art. Nr.	EAN Code	H [mm]	l [mm]	s [mm]	w [mm]	Hole pattern Dia. of the hole/nr. of holes	
FG02300011001505	5410439342698	100	150	5	25	Ø5,5/4	25



Koppelplaat - 135°

Equerre d'assemblage - 135°

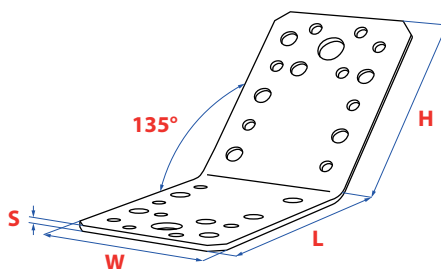

Merging square - 135°

Strebenverbinder - 135°

FG231



DoPn° FG231001



Art. Nr.	EAN Code	w [mm]	l [mm]	s [mm]	h [mm]	
FG02310010650905*	5410439360913	65	90	2,5	90	50



Kroonlijsthaak - 90°

Equerre de corniche - 90°

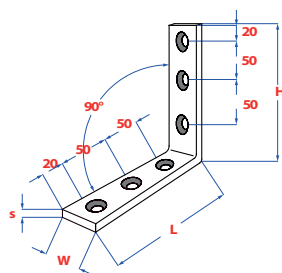

Cornice bracket - 90°

Karniesenwinkel - 90°

FG233



Art. Nr.	EAN Code	H [mm]	l [mm]	s [mm]	w [mm]	Hole pattern Dia. of the hole/nr. of holes	
FG02330011500805	5410439269131	150	80	5	25	Ø5,5/4	25
FG02330011501105	5410439269148	150	100	5	25	Ø5,5/4	25



Kroonlijsthaak - 90°

Equerre de corniche - 90°

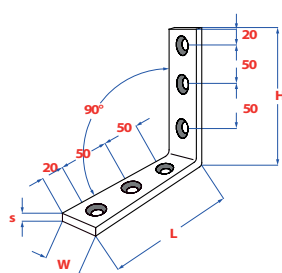

Cornice bracket - 90°

Karniesenwinkel - 90°

FG233



Art. Nr.	EAN Code	H [mm]	l [mm]	s [mm]	w [mm]	Hole pattern Dia. of the hole/nr. of holes	
FG02330031501105	5410439269155	150	100	5	25	Ø5,5/4	25



Ongelijkbenige versterkingshoek

Equerre simple scalène

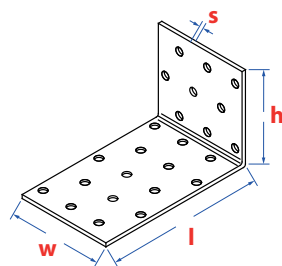

Assembly square scalene

Lochplattenwinkel ungleichschenkllich

FG235



DoPn° FG235001A

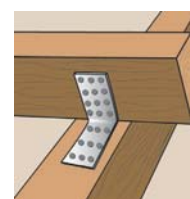

Art. Nr.	EAN Code	w [mm]	l [mm]	s [mm]	h [mm]	Hole pattern Dia. of the hole/nr. of holes	
FG02350010570755	5410439273107	57	75	2	50	Ø4/8 - Ø6/4 - Ø9/2	100
FG02350010600605*	5410439344661	60	60	2,5	-	Ø5/7 - Ø5/13	100
FG02350010600805*	5410439344685	60	80	2,5	-	Ø5/7 - Ø5/13	50
FG02350010601005*	5410439344647	60	100	2,5	-	Ø5/7 - Ø5/13	50
FG02350010750255	5410439341554	75	25	-	-	Ø5,5/5	100
FG02350011150405	5410439341578	115	60	2,5	40	Ø5,5/8	20



Versterkingshoek - Multigaten

Equerre - Multi-trous

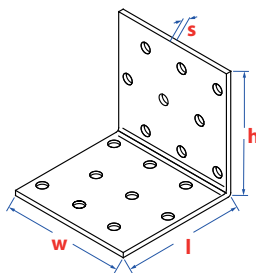

Assembly square - Multi holes

Lochplattenwinkel



DoPn° FG236001A

FG236

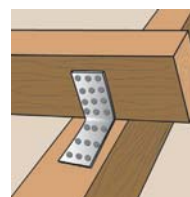

Art. Nr.	EAN Code	w [mm]	l [mm]	s [mm]	h [mm]	Hole pattern Dia. of the hole/nr. of holes	
FG02360010200405*	5410439322454	20	40	2	40	Ø5/4	200
FG02360010300305*	5410439360838	30	30	2	30	-	100
FG02360010400405*	5410439322478	40	40	2	40	Ø5/6	100
FG02360010400505*	5410439322492	40	50	2	50	Ø5/12	100
FG02360010400605*	5410439322638	40	60	2	60	Ø5/10	100
FG02360010500605*	5410439322652	50	60	2	60	Ø5/12	50
FG02360010600605*	5410439322676	60	60	2	60	Ø5/16	50
FG02360011000405*	5410439360517	100	40	2	40	-	10
FG02360012000405*	5410439360852	200	40	2	40	-	50



Versterkingshoek - Multigaten

Equerre - Multi-trous

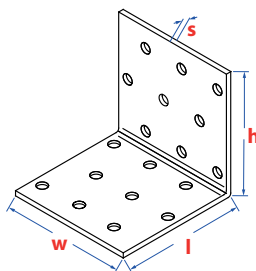



Assembly square - Multi holes

Lochplattenwinkel

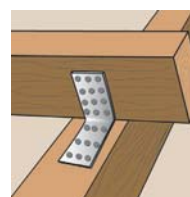

FG236



Art. Nr.	EAN Code	w [mm]	l [mm]	s [mm]	h [mm]	Hole pattern Dia. of the hole/nr. of holes	
FG0236A000300305	5410439375252	30	30	2	30	-	50
FG0236A000400405	5410439361774	40	40	2	40	Ø5/6	50
FG0236A000400505	5410439361750	40	50	2	50	Ø5/12	50
FG0236A000400605	5410439361699	40	60	2	60	Ø5/12	50
FG0236A000600405	5410439361736	60	40	2	40	Ø5/6	50
FG0236A000600605	5410439361712	60	60	2	60	Ø5/18	50

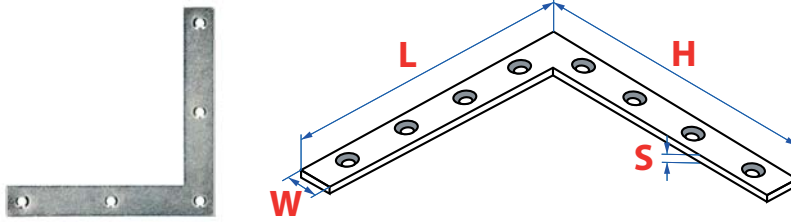

Raamhoek - 90°

Equerre pour meubles - 90°

Door angle - 90°

Flachwinkel - 90°

FG237

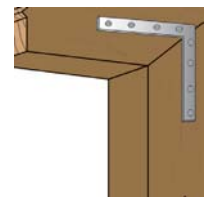

Art. Nr.	EAN Code	w [mm]	l [mm]	s [mm]	h [mm]	Hole pattern Dia. of the hole/nr. of holes	
FG02370010100305	5410439321822	10	30	1,3	30	Ø3/4	100
FG02370010100405	5410439321846	10	40	1,3	40	Ø3/4	100
FG02370010100505	5410439321860	10	50	1,3	50	Ø3/4	100
FG02370010100635	5410439321884	10	63	1,3	63	Ø3/4	100
FG02370010120755	5410439321907	12	75	1,3	75	Ø4/4	100
FG02370010151005	5410439321921	15	100	1,5	100	Ø4/5	50
FG02370010200755	5410439272469	20	75	2	75	Ø4/5	100
FG02370010201205	5410439321945	20	120	1,7	120	Ø4/5	50
FG02370010201505	5410439321969	20	150	2	150	Ø4/5	50
FG02370010302005	5410439507806	30	200	2,8	200	Ø6,5/6	25
FG02370010302505	5410439507813	30	250	2,8	250	Ø6/6	25



T-verbindingssplaat

Equerre modèle T

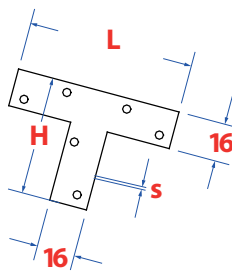

T-ridge

T-winkel

FG240



Art. Nr.	EAN Code	H [mm]	l [mm]	s [mm]	Hole pattern Dia. of the hole/nr. of holes	
FG02400020700505	5410439342742	70	50	2	Ø4/6	100



Versterkingshoek - Multigaten

Equerre - Multi-trous

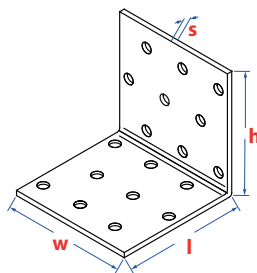

Assembly square - Multi holes

Lochplattenwinkel



DoPn° FG241001A

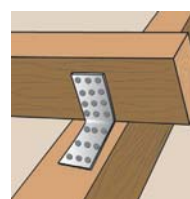

FG241



Art. Nr.	EAN Code	w [mm]	l [mm]	s [mm]	h [mm]	Hole pattern Dia. of the hole/nr. of holes	
FG02410010400605*	5410439360234	40	60	2,5	60	Ø5/6 - Ø5/12	100
FG02410010421255	5410439360999	42	125	2,5	125	4,5/10-6,5/6-10,5/1-10X20/1	50
FG02410010500605*	5410439360159	50	60	2,5	60	Ø5/7 - Ø5/15	100
FG02410010600405*	5410439322614	60	40	2,5	40	Ø5/5 - Ø5/10	100
FG02410010600605*	5410439360258	60	60	2,5	60	Ø5/9 - Ø5/18	100
FG02410010600805*	5410439322713	60	80	2,5	80	Ø5/10 - Ø5/10	50
FG02410010601005*	5410439322751	60	100	2,5	100	Ø5/13 - Ø5/12	50
FG02410010800605*	5410439360173	80	60	2,5	60	Ø5/11 - Ø5/21	50
FG02410010800805*	5410439322737	80	80	2,5	80	Ø5/14 - Ø5/14	50
FG02410010801005*	5410439360210	80	100	2,5	100	Ø5/17 - Ø5/18	50
FG02410011000605*	5410439322690	100	60	2,5	60	Ø5/14 - Ø5/13	50
FG02410011001005*	5410439322775	100	100	2,5	100	Ø5/23 - Ø5/45	25



Versterkingshoek

Equerre symétrique

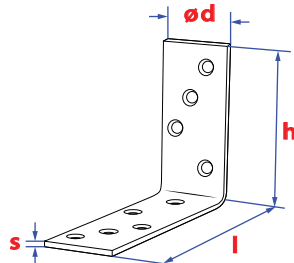

Frame connector

Breitwinkel

FG242



Art. Nr.	EAN Code	d [mm]	l [mm]	s [mm]	h [mm]	Hole pattern Dia. of the hole/nr. of holes	
FG02420010300755	5410439360951	30	100	3	75	Ø5,3/7	20
FG02420010400655	5410439360937	40	65	4	65	Ø4,5/8 - Ø8,1/2	20
FG02420010400855	5410439360975	40	125	4	85	Ø6/9	20



T-verbindingsplaat - Breed

Equerre en T - Large

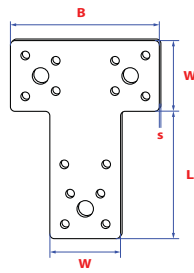

T-ridge large

T-Winkel - breit

FG243



Art. Nr.	EAN Code	B [mm]	l [mm]	s [mm]	w [mm]	
FG02430018068385	5410439269124	80	68	2	38	50



Garden fixings

Tuinbevestigingen

Fixations de jardin

Gartenbefestigungen

FG251

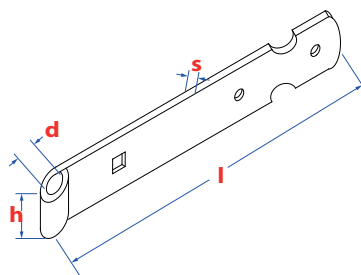

Rechte heng
Penture droite

Straight hinge
Ladenband gerade



Art. Nr.	EAN Code	d [mm]	l [mm]	s [mm]	h [mm]	Hole pattern Dia. of the hole/nr. of holes	
FG02510011603005	5410439567961	16	300	5	37,5	Ø8,2/1 - Ø8,8/1	10
FG02510011604005	5410439568005	16	400	5	37,5	Ø8,2/2 - Ø8,8/1	10
FG02510011605005	5410439568142	16	500	5	44,5	Ø8,2/3 - Ø8,8/1	10
FG02510011606005	5410439568166	16	600	5	44,5	Ø8,2/3 - Ø8,8/1	10
FG02510011607005	5410439568180	16	700	5	44,5	Ø8,2/3 - Ø8,8/1	10
FG02510011608005	5410439568203	16	800	5	44,5	Ø8,2/4 - Ø8,8/1	10
FG02510011609005	5410439568227	16	900	5,5	44,5	Ø8,2/5 - Ø8,8/1	10
FG02510011610005	5410439568241	16	1000	5,5	44,5	Ø8,2/5 - Ø8,8/1	10
FG02510011612005	5410439568265	16	1200	5,5	44,5	Ø8,2/5 - Ø8,8/1	10

FG251

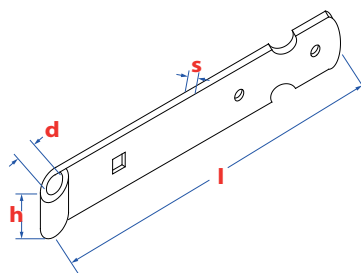

Rechte heng
Penture droite

Straight hinge
Ladenband gerade



Art. Nr.	EAN Code	d [mm]	l [mm]	s [mm]	h [mm]	Hole pattern Dia. of the hole/nr. of holes	
FG02510021604005	5410439230377	16	400	5	40	Ø8,2/2 - Ø8,8/1	10
FG02510021605005	5410439231374	16	500	6	45	Ø8,2/3 - Ø8,8/1	10
FG02510021607005	5410439231398	16	700	6	45	Ø8,2/3 - Ø8,8/1	10
FG02510021608005	5410439231404	16	800	6	45	Ø8,2/4 - Ø8,8/1	10
FG02510021609005	5410439231411	16	900	6	45	Ø8,2/5 - Ø8,8/1	10
FG02510021610005	5410439231428	16	1000	6	45	Ø8,2/5 - Ø8,8/1	10
FG02510021612005	5410439231435	16	1200	6	45	Ø8,2/5 - Ø8,8/1	10

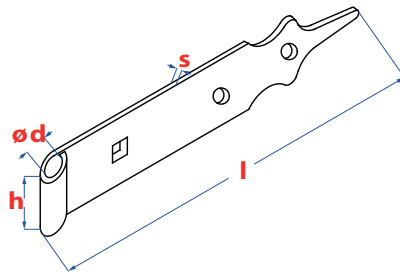

FG252

Heng - Rustica

Penture - Rustica

Hinge - Rustica

Ladenband - Rustica

Deltacoll®
Black

Art. Nr.	EAN Code	d [mm]	l [mm]	s [mm]	h [mm]	Hole pattern Dia. of the hole/nr. of holes	
FG02520031604005	5410439442640	16	400	5	44	Ø8,2/2 - Ø8,3/1	10
FG02520031606005	5410439442664	16	600	5	44	Ø8,2/3 - Ø8,3/1	10
FG02520031608005	5410439442688	16	800	5	44	Ø8,2/4 - Ø8,3/1	10
FG02520031610005	5410439442701	16	1000	5	44	Ø8,2/5 - Ø8,3/1	10

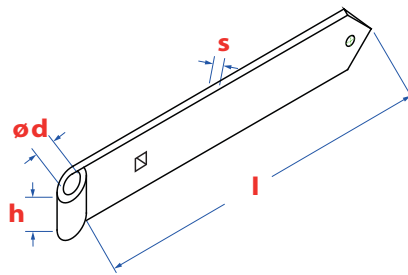

FG253

Heng met punt

Penture pointu

Hinge with point

Ladenband mit Punkt

GZ
yellow
zinc.pl.

Art. Nr.	EAN Code	d [mm]	l [mm]	s [mm]	h [mm]	Hole pattern Dia. of the hole/nr. of holes	
FG02530021606005	5410439392914	16	600	5	45	Ø8,2/3 - Ø8,8/1	10
FG02530021607005	5410439392945	16	700	5	45	Ø8,2/3 - Ø8,8/1	10
FG02530021608005	5410439392952	16	800	5	45	Ø8,2/4 - Ø8,8/1	10
FG02530021610005	5410439392969	16	1000	5,5	45	Ø8,2/5 - Ø8,8/1	10
FG02530021612005	5410439392976	16	1200	5,5	45	Ø8,2/5 - Ø8,8/1	10
FG02530021802005	5410439687379	18	200	4	30	Ø8,5/2	10
FG02530021802505	5410439643603	18	250	4	30	Ø8,5/3	10
FG02530021803005	5410439628310	18	300	4	30	Ø8,5/3	10
FG02530021803505	5410439628273	18	350	4	30	Ø8,5/3	10
FG02530021804005	5410439568029	18	400	4	30	Ø8,5/4	10
FG02530021805005	5410439375672	18	500	4	30	Ø8,5/5	10

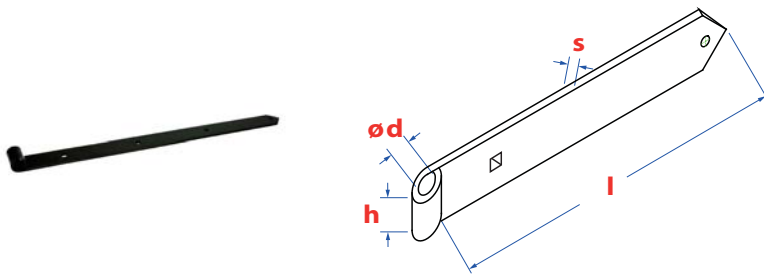

Heng met punt

Penture pointu

Hinge with point

Ladenband mit Punkt

Deltacol®
Black

FG253

Art. Nr.	EAN Code	d [mm]	l [mm]	s [mm]	h [mm]	Hole pattern Dia. of the hole/nr. of holes	
FG02530031606005	5410439569224	16	600	5	45	Ø8,5/3	6
FG02530031607005	5410439569248	16	700	5	45	Ø8,5/3	6
FG02530031608005	5410439569262	16	800	5	45	Ø8,5/4	2
FG02530031610005	5410439569330	16	1000	5,5	45	Ø8,5/5	6
FG02530031612005	5410439569354	16	1200	5,5	45	Ø8,5/5	6
FG02530031802005	5410439569378	18	200	4	30	Ø8,5/2	10
FG02530031802505	5410439569439	18	250	4	30	Ø8,5/3	10
FG02530031803005	5410439569392	18	300	4	30	Ø8,5/3	10
FG02530031803505	5410439569415	18	350	4	30	Ø8,5/3	10
FG02530031804005	5410439569453	18	400	4	30	Ø8,5/4	10
FG02530031805005	5410439569477	18	500	4	30	Ø8,5/5	10

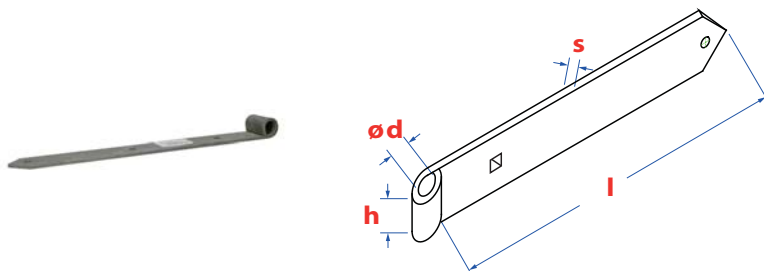

Heng met punt

Penture pointu

Hinge with point

Ladenband mit Punkt

VV
hdg

FG253

Art. Nr.	EAN Code	d [mm]	l [mm]	s [mm]	h [mm]	Hole pattern Dia. of the hole/nr. of holes	
FG02530101603005	5410439624299	16	300	6	45	Ø8,5/1	10
FG02530101604005	5410439624312	16	400	6	45	Ø8,5/2	10
FG02530101605005	5410439624336	16	500	6	45	Ø8,5/3	10
FG02530101606005	5410439624350	16	600	6	45	Ø8,5/3	10
FG02530101607005	5410439624374	16	700	6	45	Ø8,5/3	10
FG02530101608005	5410439624398	16	800	6	45	Ø8,5/4	10
FG02530101609005	5410439624411	16	900	6	45	Ø8,5/5	10
FG02530101610005	5410439624251	16	1000	6	45	Ø8,5/5	10
FG02530101612005	5410439624275	16	1200	6	45	Ø8,5/5	10

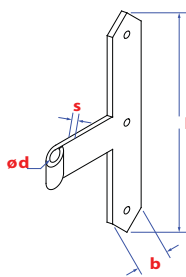

FG254

Draailuikheng - T model

Penture équerre pièce interm. - Forme T

Shutter hinge - T-model

Winkelband - geschweisst



Art. Nr.	EAN Code	d [mm]	l [mm]	b [mm]	s [mm]	Hole pattern Dia. of the hole/nr. of holes	
FG02540021801505	5410439393089	18	150	30	4	Ø8,5/3	10
FG02540021802005	5410439393096	18	200	30	4	Ø8,5/3	10

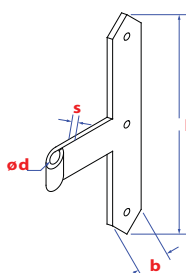

FG254

Draailuikheng - T model

Penture équerre pièce interm. - Forme T

Shutter hinge - T-model

Winkelband - Form T



Art. Nr.	EAN Code	d [mm]	l [mm]	b [mm]	s [mm]	Hole pattern Dia. of the hole/nr. of holes	
FG02540031801505	5410439569583	18	150	30	4	Ø8,5/3	10
FG02540031802005	5410439569606	18	200	30	4	Ø8,5/3	10

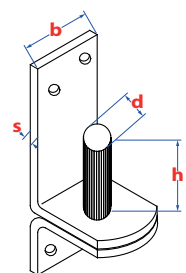

FG255

Plaatduim

Gond sur platine

Plate pintle

Haken zum aufschrauben



Art. Nr.	EAN Code	d [mm]	l [mm]	b [mm]	s [mm]	Hole pattern Dia. of the hole/nr. of holes	
FG02550011645385	5410439568289	16	45	40	5	Ø5,7/6	10

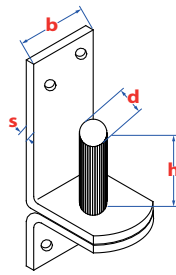

FG255

Plaatduim

Gond sur platine

Plate pintle

Haken zum aufschrauben



Art. Nr.	EAN Code	d [mm]	l [mm]	b [mm]	s [mm]	Hole pattern Dia. of the hole/nr. of holes	
FG02550021645385	5410439393119	16	45	40	5	Ø5,7/6	10
FG02550021835305	5410439393133	18	40	33	4	Ø5,5/6	10
FG02550021845385	5410439393126	18	45	40	5	Ø5,5/6	10

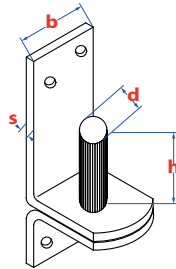

FG255

Plaatduim

Gond sur platine

Plate pintle

Haken zum aufschrauben



Art. Nr.	EAN Code	d [mm]	l [mm]	b [mm]	s [mm]	Hole pattern Dia. of the hole/nr. of holes	
FG02550031645385	5410439569699	16	45	40	5	Ø6,2/6	10
FG02550031835305	5410439569712	18	40	33	4	Ø5,5/6	10

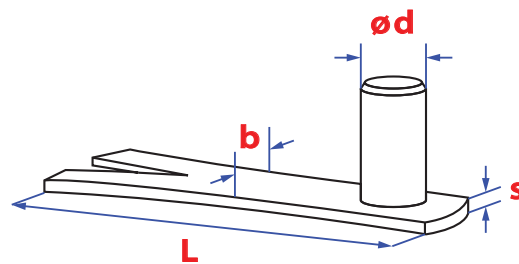

FG256

Betonduim

Gond à bétonner

Pintle for concrete

Haken zum betonieren



Art. Nr.	EAN Code	d [mm]	l [mm]	b [mm]	s [mm]	
FG0256002181055	5410439625111	18	105	30	4	10

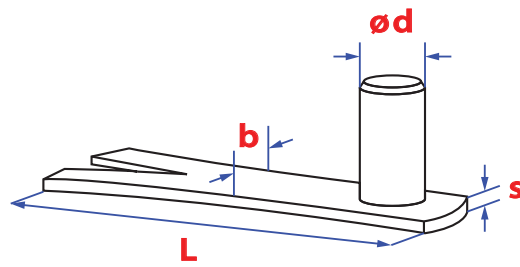

FG256

Betonduim
Gond à bétonner

Pintle for concrete
Haken zum betonieren

Deltacoll®
Black

Art. Nr.	EAN Code	d [mm]	l [mm]	b [mm]	s [mm]	
FG0256003181055	5410439625135	18	105	30	4	10

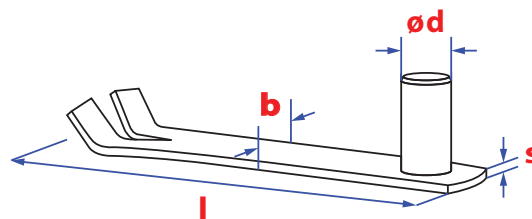

FG257

Klauwduim voor baksteen
Gond à maçonner

Pintle for bricklaying
Haken zum einmauern



Art. Nr.	EAN Code	d [mm]	l [mm]	b [mm]	s [mm]	
FG0257001161505	5410439625005	16	150	30	4	10

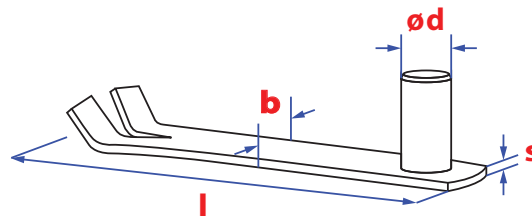

FG257

Klauwduim voor baksteen
Gond à maçonner

Pintle for bricklaying
Haken zum einmauern



Art. Nr.	EAN Code	d [mm]	l [mm]	b [mm]	s [mm]	
FG0257002181505	5410439625029	18	150	30	4	10

FG257

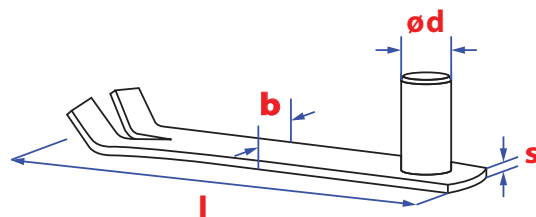

Klawduim voor baksteen

Pintle for bricklaying

Gond à maçonner

Haken zum einmauern

Deltacol®
Black

Art. Nr.	EAN Code	d [mm]	l [mm]	b [mm]	s [mm]	
FG0257003181505	5410439625081	18	150	30	4	10

FG258

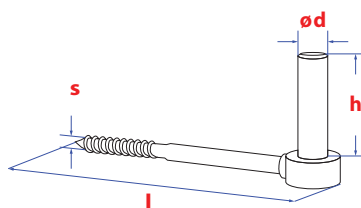

Schroefduim

Lag screw pintle

Gond à vis à bois

Haken zum einschrauben



Art. Nr.	EAN Code	d [mm]	l [mm]	s [mm]	h [mm]	
FG0258001161005	5410439569804	16	100	10	55	10

FG258

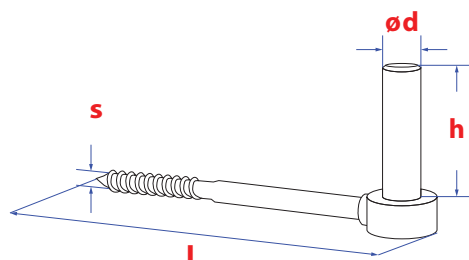

Schroefduim

Lag screw pintle

Gond à vis à bois

Haken zum einschrauben



Art. Nr.	EAN Code	d [mm]	l [mm]	s [mm]	h [mm]	
FG0258002161005	5410439393140	16	100	10	55	10
FG0258002181005	5410439687492	18	100	12	35	10

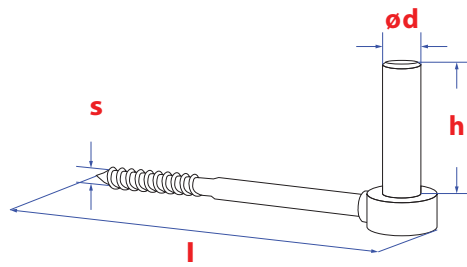

FG258

Schroefduim

Gond à vis à bois

Lag screw pintle

Haken zum einschrauben

Deltacol[®]
Black

Art. Nr.	EAN Code	d [mm]	l [mm]	s [mm]	h [mm]	
FG0258003161455	5410439624565	16	145	10	55	10
FG0258003181005	5410439624541	18	100	12	35	10

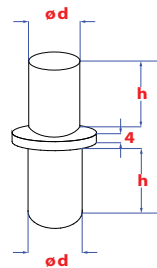

FG259

Veiligheidsstift

Axe infraudable

Safety pintle

Sicherungsstift

GZ
yellow
zinc pl.

Art. Nr.	EAN Code	d [mm]	l [mm]	h [mm]	
FG0259002180755	5410439625159	18	75	35	10

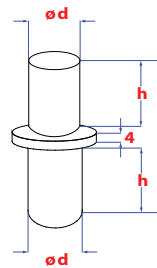

FG259

Veiligheidsstift

Axe infraudable

Safety pintle

Sicherungsstift

Deltacol[®]
Black

Art. Nr.	EAN Code	d [mm]	l [mm]	h [mm]	
FG0259003180755	5410439625173	18	75	35	10

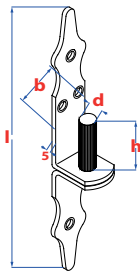

FG260

Plaatduim - Rustica

Plate pintle - Rustica

Gond sur platine - Rustica

Haken zum aufschrauben - Rustica

Deltacol®
Black

Art. Nr.	EAN Code	d [mm]	l [mm]	b [mm]	Hole pattern Dia. of the hole/nr. of holes	
FG02600031645455	5410439458085	16	45	44	Ø7,6/4	10

FG265

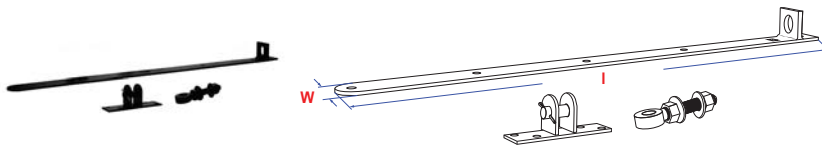

Verstelbaar heng - zwart

Adjustable hinge - Black

Penture réglable - noire

Ladenband verstellbar - schwarz

Deltacol®
Black

Art. Nr.	EAN Code	w [mm]	l [mm]	
FG02650024007005	5410439274203	40	700	10

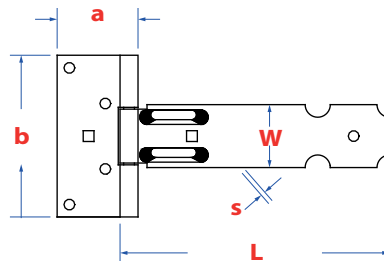

FG300

Kruisheng - Licht type

Cross hinge - Light version

Penture en croix - Forme Légère

Kreuzgehänge - leicht

GZ
yellow
zinc pl.

Art. Nr.	EAN Code	w [mm]	l [mm]	s [mm]	Hole pattern Dia. of the hole/nr. of holes	
FG03000020201005	5410439330749	20	100	2	Ø4,1/6 - Ø5,2/1	6
FG03000020201505	5410439342339	20	150	2	Ø4,1/6 - Ø5,2/1	6
FG03000020352005	5410439342353	35	200	2	Ø5,2/6 - Ø8,8/2	6
FG03000020352505	5410439330763	35	250	2	Ø5,2/6 - Ø8,8/2	6
FG03000020353005	5410439342377	35	300	2	Ø5,2/7 - Ø8,8/2	6
FG03000020355005	5410439510578	35	500	2	Ø5,2/9 - Ø8,8/5	6

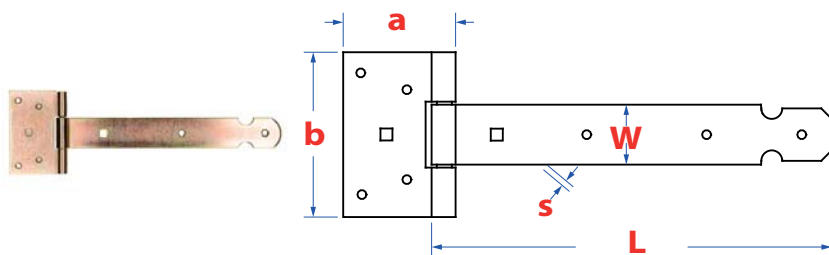

FG301

Kruisheng - Zwaar type

Cross hinge - Heavy duty type

Penture en croix - Forme lourde

Kreuzgehänge - schwer



Art. Nr.	EAN Code	w [mm]	l [mm]	s [mm]	Hole pattern Dia. of the hole/nr. of holes	
FG03010020403005	5410439342391	40	300	4	Ø6,4/2 - Ø5,5/4 - Ø8,4/2	6
FG03010020404005	5410439342414	40	400	4	Ø6,4/2 - Ø5,5/4 - Ø8,4/2	6
FG03010020405005	5410439342438	40	500	4	Ø6,4/3 - Ø5,5/4 - Ø8,4/2	6
FG03010020406005	5410439330817	40	600	4	-	10

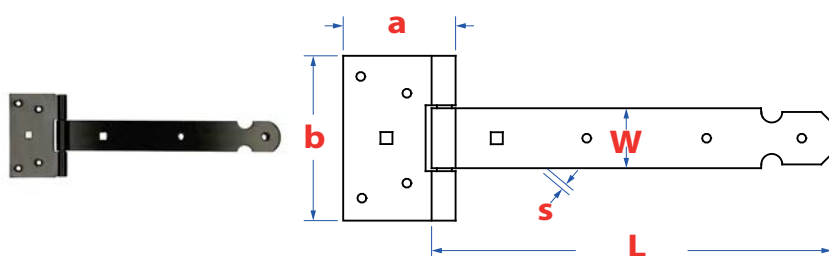

FG301

Kruisheng - Zwaar type

Cross hinge - Heavy duty type

Penture en croix - Forme lourde

Kreuzgehänge - schwer



Art. Nr.	EAN Code	w [mm]	l [mm]	s [mm]	Hole pattern Dia. of the hole/nr. of holes	
FG03010030403005	5410439482059	40	300	4	Ø6,4/2 - Ø5,5/4 - Ø8,4/2	6
FG03010030404005	5410439482066	40	400	4	Ø6,4/2 - Ø5,5/4 - Ø8,4/2	6
FG03010030405005	5410439482073	40	500	4	Ø6,4/3 - Ø5,5/4 - Ø8,4/2	6
FG03010030406005	5410439482080	40	600	4	-	6

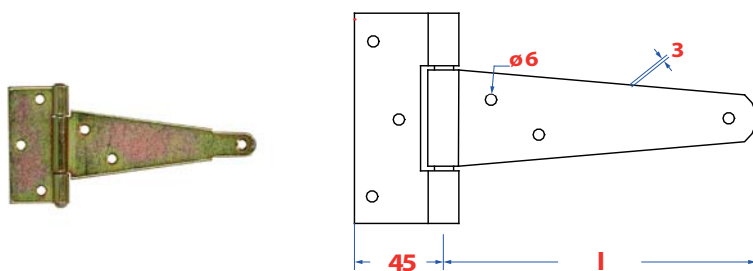

FG302

T-Heng

T-Hinge

Penture anglaise

T-Gehänge



Art. Nr.	EAN Code	l [mm]	
FG03020020755	5410439625227	75	12
FG03020021005	5410439393171	100	12
FG03020021255	5410439625272	125	12
FG03020021505	5410439625296	150	12



T-Heng

Penture anglaise

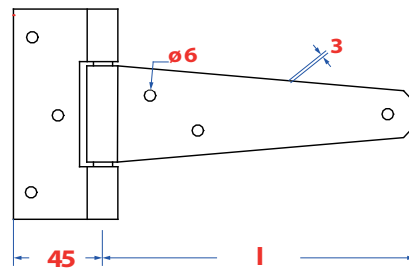

T-Hinge

T-Gehänge

FG302



Art. Nr.	EAN Code	l [mm]	
FG03020021755	5410439393188	175	6
FG03020022005	5410439625319	200	6
FG03020022505	5410439625333	250	6
FG03020023005	5410439393195	300	6



T-heng

Penture Anglaise

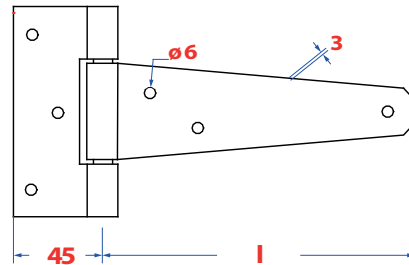

T-strap hinge

T-Gehänge

FG302



Art. Nr.	EAN Code	l [mm]	
FG03020031005	5410439628648	100	12
FG03020031255	5410439628662	125	12
FG03020031505	5410439628686	150	12



Staarheng - Licht type

Penture anglaise double - Forme légère

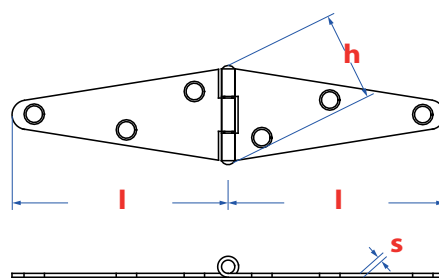

Straight strap hinge - Light version

Scharnier - leicht

FG303



Art. Nr.	EAN Code	l [mm]	h [mm]	s [mm]	
FG03030010755	5410439568302	75	27	1,5	10
FG03030011005	5410439568326	100	30	1,75	10
FG03030011255	5410439568340	125	34	2	10
FG03030011505	5410439568364	150	38	2	10
FG03030012005	5410439568388	200	44	2	10
FG03030012505	5410439568401	250	50	2	10

FG304

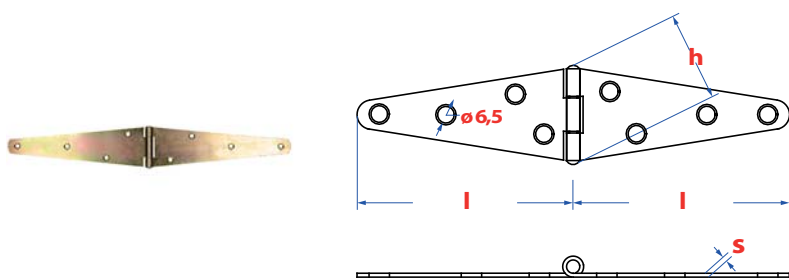

Dubbele staartscharnier - Zwaar type

Double tailhinge - Heavy version

Penture double - Forme forte

Doppelten Kistenband - schwer



Art. Nr.	EAN Code	l [mm]	h [mm]	s [mm]	
FG03040022005	5410439331968	200	50	2,5	12
FG03040022505	5410439395663	250	50	2,5	12
FG03040023005	5410439395670	300	50	2,5	12

FG307

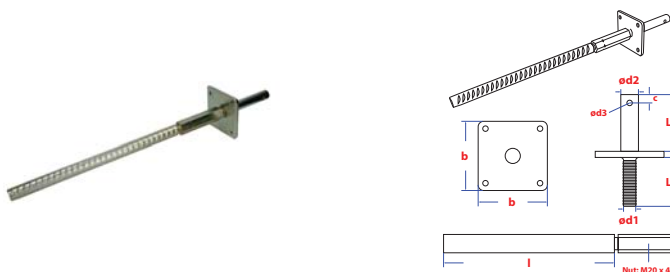

Verstelbaar instortanker m. pin

Adjustable anchor

Ancrage réglable

Stützenfuss verstellbar m. Stange



Art. Nr.	EAN Code	d [mm]	l [mm]	b [mm]	d2 [mm]	
FG03070011101105	5410439034968	110	110	8	24	10



Balkenvoet met betonijzer - L type

Column shoe with rebar - L type

Pied de poteau avec fer de béton - Forme L

Pfostenrager mit Riffeldolle - Form L

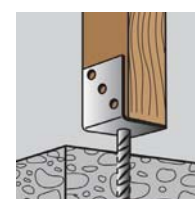

FG310



Art. Nr.	EAN Code	w [mm]	l [mm]	s [mm]	h [mm]	Hole pattern Dia. of the hole/nr. of holes	
FG03100100600915	5410439343756	60	80	4	100	Ø11/3	10

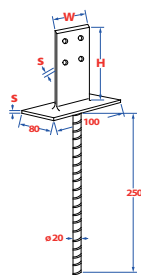

FG311

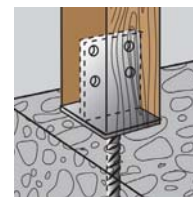

Balkenvoet met betonijzer - T type

Column shoe with rebar - T type

Pied de poteau avec fer de béton - Forme T

Pfostenhalter mit Riffeldolle - Form T



Art. Nr.	EAN Code	w [mm]	h [mm]	s [mm]	Hole pattern Dia. of the hole/nr. of holes	
FG03110100701105	5410439343848	70	110	8	Ø10/4	10

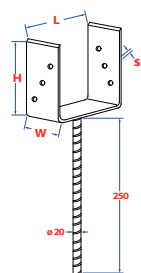

FG312

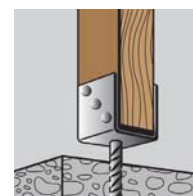

Balkenvoet met betonijzer - U type

Column shoe with rebar - U type

Pied de poteau avec fer de béton - Forme U

Pfostenhalter mit Riffeldolle - Form U



Art. Nr.	EAN Code	w [mm]	l [mm]	s [mm]	h [mm]	Hole pattern Dia. of the hole/nr. of holes	
FG03120100600715	5410439343770	60	71	4	100	Ø11/6	10
FG03120100600815	5410439343794	60	81	4	100	Ø11/6	10
FG03120100600915	5410439343817	60	91	4	100	Ø11/6	10

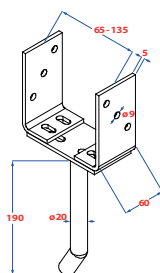

FG313

Pergolasteun met betonijzer

Pergola support with rebar

Support de Pergola avec fer pour béton

Pergola-Unterstützung mit Dolle



Art. Nr.	EAN Code	d [mm]	l [mm]	Hole pattern Dia. of the hole/nr. of holes	
FG03130100651355	5410439272971	65	190	Ø9/6	1

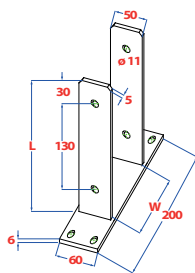

FG316



DoPn° FG316001

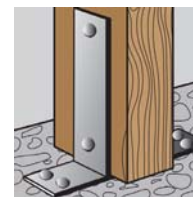

Balkenvoet met bevestigingspl. - U type

Column shoe with anchoring pl. - U type

Pied de poteau avec patte de fix. - Forme U

Pfosträger zum aufdübeln - Form U



Art. Nr.	EAN Code	w [mm]	I [mm]	Hole pattern Dia. of the hole/nr. of holes	
FG03160100712005*	5410439343909	71	200	Ø11/8	10
FG03160100812005	5410439343923	81	200	Ø11/8	10
FG03160100912005	5410439343947	91	200	Ø11/8	10

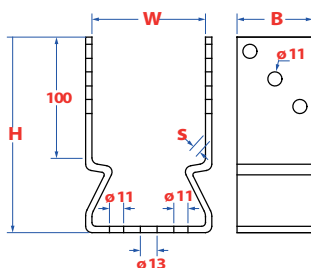

FG317

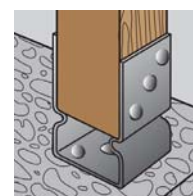

Balkenv. met opschroefb. steun - U type

Column shoe - U type

Support de poutre - Forme U

Pfosträger U mit Balkenaufgabe



Art. Nr.	EAN Code	w [mm]	H [mm]	b [mm]	s [mm]	Hole pattern Dia. of the hole/nr. of holes	
FG03170100711505	5410439361552	71	150	60	5	Ø11/8 - Ø13/1	1
FG03170100911505	5410439361569	91	150	60	5	Ø11/8 - Ø13/1	1

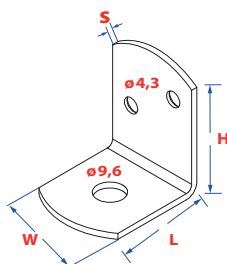

FG319

Vlechtschermsteun vorm "L" (los)

Fence holder - L type

Support panneau tresse - Forme L

Flechtzaunbeschlagn - Form L



Art. Nr.	EAN Code	d [mm]	I [mm]	s [mm]	h [mm]	w [mm]	Hole pattern Dia. of the hole/nr. of holes	
FG0319A000305	5410439007405	30	35	2	40	30	2/4,3 - 1/9,6	250

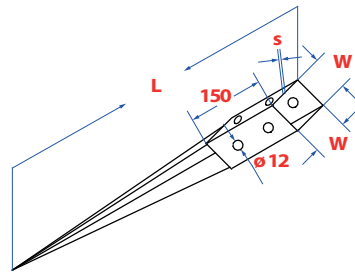

FG320

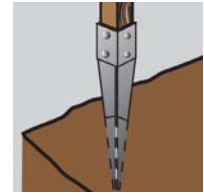

Paalhouder met punt

Pointed pole anchor

Pied de poteau de jardin pointu

Pfosträger Rakete



Art. Nr.	EAN Code	w [mm]	l [mm]	s [mm]	Hole pattern Dia. of the hole/nr. of holes	
FG03200100717505	5410439343961	71	750	2	Ø11/4	1
FG03200100917505	5410439386425	91	750	2	Ø11/4	1
FG03200100919005	5410439343978	91	900	2	Ø11/4	1

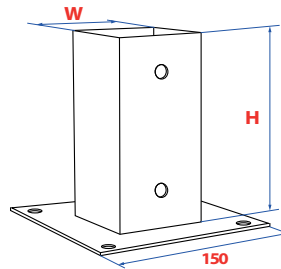

FG321

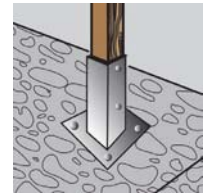

Paalhouder op plaat

Post holder with anchor plate

Pied de poteau avec patte d'ancrage

Pfosträger mit Grundplatte



Art. Nr.	EAN Code	w [mm]	H [mm]	s [mm]	Hole pattern Dia. of the hole/nr. of holes	
FG03210100711505	5410439343985	71	150	2	Ø10,5/12	1
FG03210100911505	5410439343992	91	150	2	Ø10,5/12	1
FG03210101211505	5410439027274	121	150	2	-	1
FG03210101451505	5410439015905	145	150	2	Ø10,5/8	1

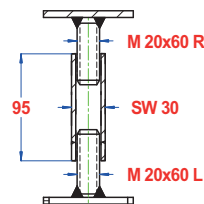
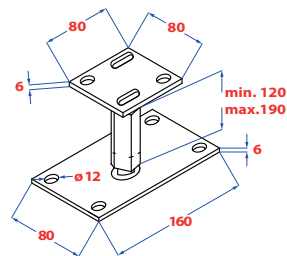

FG322



DoPn° FG322001

Paalhouder verstelbare hoogte - P type

Hight adjustable post holder - P type

Pied de poteau ajust. en hauteur - Forme P

Pfosträger Höhenverstellung - Typ P



Art. Nr.	EAN Code	d [mm]	l [mm]	Hole pattern Dia. of the hole/nr. of holes	
FG0322002801605*	5410439339698	80	160	Ø13/6 - Ø23X13/2	10

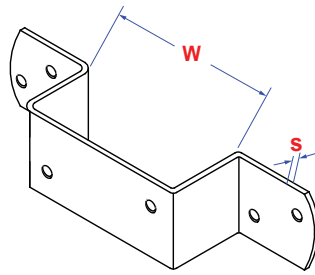

FG324

Vlechtschermsteun combi

Fence holder combi

Support panneau tresse combi

Flechtzaunbeschlag combi



Art. Nr.	EAN Code	w [mm]	s [mm]	
FG03240020700705	5410439568722	70	2	100
FG03240020900905	5410439568739	90	2	100

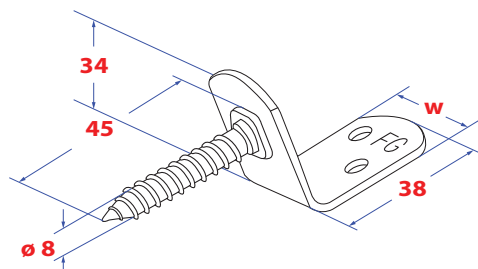

FG325

Vlechtschermsteun vorm "L" (los)

Fence holder - L type

Support panneau tresse - Forme L

Flechtzaunbeschlag - Form L



Art. Nr.	EAN Code	w [mm]	s [mm]	Hole pattern Dia. of the hole/nr. of holes	
FG03250020305	5410439344098	30	2	Ø5/2	100

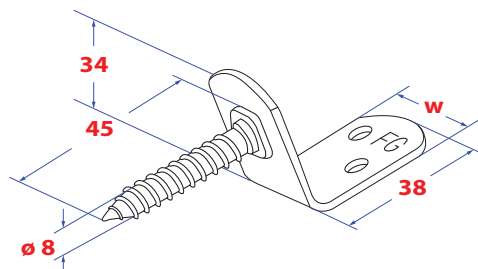

FG325

Vlechtschermsteun vorm "L" (per set)

Fence holder - L type

Support panneau tresse - Forme L

Flechtzaunbeschlag - Form L

4 x 

8 x 



Art. Nr.	EAN Code	w [mm]	s [mm]	Hole pattern Dia. of the hole/nr. of holes	
FG0325002SET5	5410439344104	30	2	Ø5/2	1

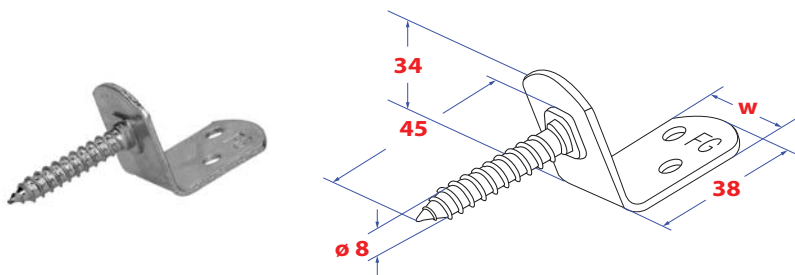

FG325



Vlechtschermsteun vorm "L" (los)
Support panneau tresse - Forme L

Fence holder - L type
Flechtzaunbeschlag - Form L



Art. Nr.	EAN Code	w [mm]	s [mm]	Hole pattern Dia. of the hole/nr. of holes	
FG03250100305	5410439344081	30	2	Ø5/2	100

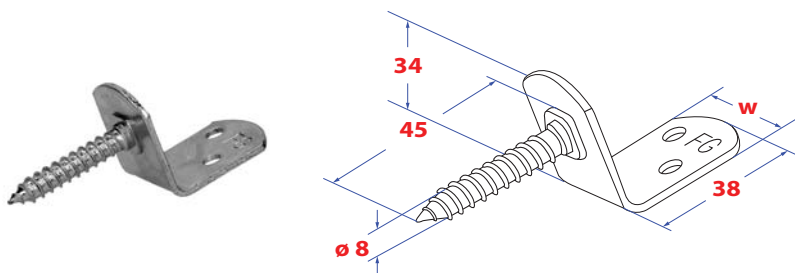

FG325

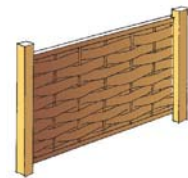

Vlechtschermsteun vorm "L" (los)
Support panneau tresse - Forme L

Fence holder - L type
Flechtzaunbeschlag - Form L



Art. Nr.	EAN Code	w [mm]	s [mm]	Hole pattern Dia. of the hole/nr. of holes	
FG0325A000305	5410439344067	30	2	Ø5/2	100

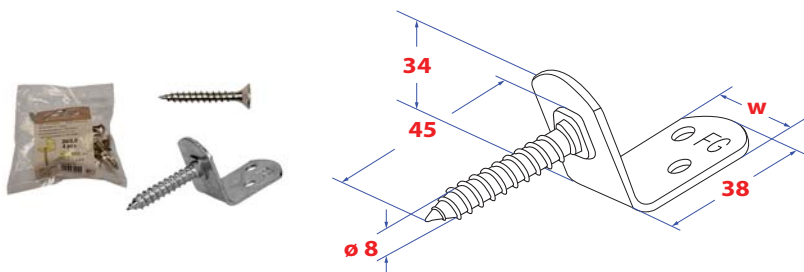

FG325

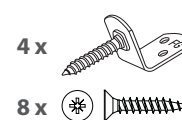

Vlechtschermsteun vorm "L" (per set)
Support panneau tresse - Forme L

Fence holder - L type
Flechtzaunbeschlag - Form L



Art. Nr.	EAN Code	w [mm]	s [mm]	Hole pattern Dia. of the hole/nr. of holes	
FG0325A00SET5	5410439632324	30	2	Ø5/2	1

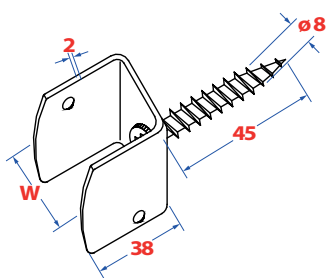

FG326

Vlechtschermsteun vorm "U"

Fence holder - U type

Support panneau tresse - Forme U

Flechtzaunbeschlag - Form U



Art. Nr.	EAN Code	w [mm]	
FG0326002385	5410439344128	38	50
FG0326002485	5410439344142	48	1

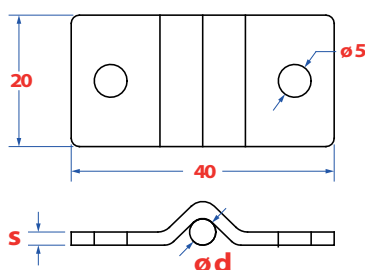

FG327

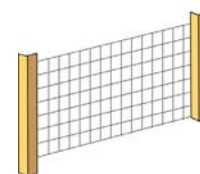

Draadpaneelklem

Bracket for panel fencing

Fixation treillis

Befestigungsschele



Art. Nr.	EAN Code	d [mm]	s [mm]	Hole pattern Dia. of the hole/nr. of holes	
FG0327001045	5410439388412	4	2	Ø5/2	100
FG0327001065	5410439393478	6	2	-	100

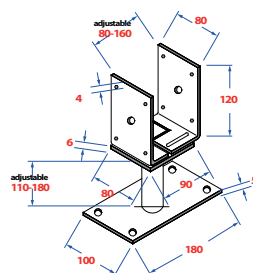

FG328

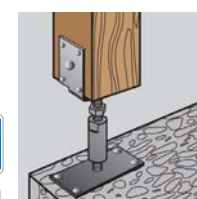

DoPn° FG328001

Verstelbare voet - in hoogte en breedte

Column shoe - Adj. in height and width

Pied de poteau - régl. en hauteur et largeur

Pfostentr. - höhen- und seitenverstellb.



Art. Nr.	EAN Code	d [mm]	l [mm]	
FG032801080160A5*	5410439343381	80	160	10

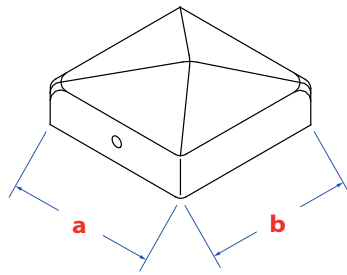

FG329

Paalkap - piramidevormig

Pole cover - Pyramid type

Ornement de poteau - Forme piramide

Pfostenkappe - Pyramideförmig



Art. Nr.	EAN Code	a [mm]	b [mm]	Hole pattern Dia. of the hole/nr. of holes	
FG03290100710715	5410439624473	71	71	Ø5/2	25
FG03290100910915	5410439624497	91	91	Ø5/2	25

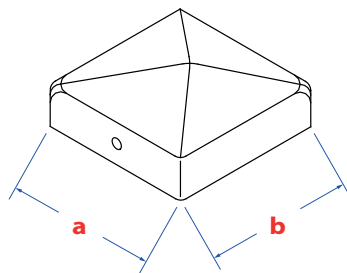

FG329

Paalkap - piramidevormig

Pole cover - Pyramid type

Ornement de poteau - Forme piramide

Pfostenkappe - Pyramideförmig



Art. Nr.	EAN Code	a [mm]	b [mm]	Hole pattern Dia. of the hole/nr. of holes	
FG0329A000710715	5410439646758	71	71	Ø5/2	25
FG0329A000910915	5410439646772	91	91	Ø5/2	25

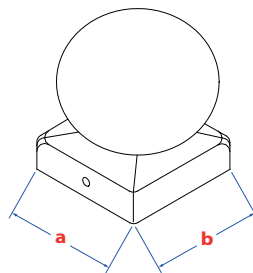

FG330

Paalkap - bolvormig

Pole cover - Ball type

Ornement de poteau - Forme boule

Pfostenkappe - Kugelförmig



Art. Nr.	EAN Code	a [mm]	b [mm]	Hole pattern Dia. of the hole/nr. of holes	
FG03300100710715	5410439568845	71	71	Ø2,5/2	25
FG03300100910915	5410439568869	91	91	Ø3/2	25

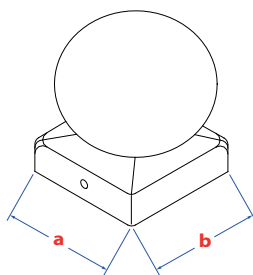

FG330

Paalkap - bolvormig

Pole cover - Ball type

Ornement de poteau - Forme boule

Pfostenkappe - Kugelförmig



Art. Nr.	EAN Code	a [mm]	b [mm]	Hole pattern Dia. of the hole/nr. of holes	
FG0330A000710715	5410439646796	71	71	Ø2,5/2	25
FG0330A000910915	5410439646819	91	91	Ø2,5/2	25

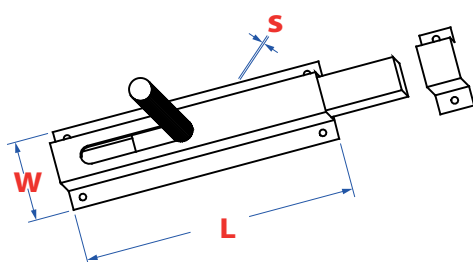

FG331

Vlakke schuif - Licht type

Plane sliding latch - Light version

Verrou de fenetre plat - Forme légère

Fensterriegel gerade



Art. Nr.	EAN Code	w [mm]	l [mm]	s [mm]	
FG0331001350605	5410439337618	35	60	1	12
FG0331001350805	5410439337632	35	80	1	12
FG0331001351005	5410439337656	35	100	1	12
FG0331001351205	5410439337670	35	120	1	12

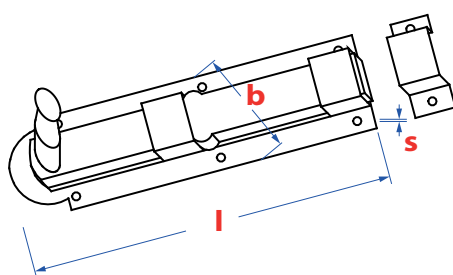

FG332

Vlakke raamschuif

Plane window sliding latch

Verrou pêne plat bouton

Schlossriegel gerade



Art. Nr.	EAN Code	b [mm]	l [mm]	s [mm]	
FG0332001200405	5410439568661	20	40	1	10
FG0332001250605	5410439568623	25	60	1	10
FG0332001250805	5410439568685	25	80	1	10
FG0332001301005	5410439568708	30	100	1	10
FG0332001301205	5410439482561	30	120	1	10

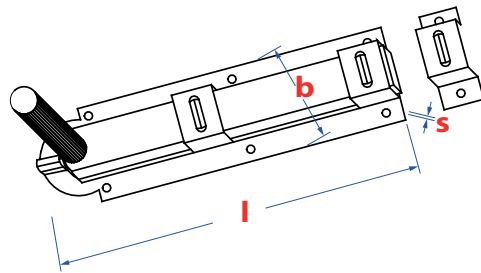

FG333

Vlakke deurrolschuif

Plane roll latch

Verrou à coulisse

Rollen-Schlossriegel gerade



Art. Nr.	EAN Code	b [mm]	l [mm]	s [mm]	Hole pattern Dia. of the hole/nr. of holes	
FG0333002451005	5410439568500	45	100	2	Ø4,6/8	10
FG0333002551205	5410439568524	55	120	2	Ø4,6/8	10
FG0333002551405	5410439568548	55	140	2	Ø4,6/8	10
FG0333002651605	5410439568555	65	160	2	Ø4,6/8	10
FG0333002751805	5410439568586	75	180	2	Ø4,6/8	5
FG0333002752005	5410439568593	75	200	2	Ø4,6/8	5

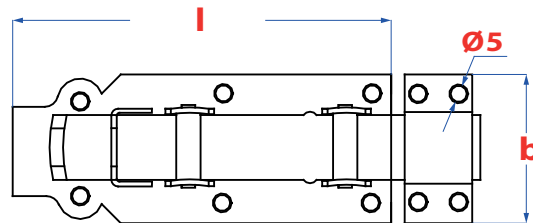

FG334

Vlakke hangslotrolschuif

Flat padlock sliding bolt

Verrou pour cadenas à rouleau plat

Rollenschlossriegel flach



Art. Nr.	EAN Code	l [mm]	b [mm]	Hole pattern Dia. of the hole/nr. of holes	
FG03340021605	5410439363167	160	70	Ø5/10	1

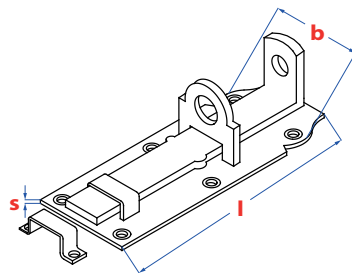

FG336

Vlakke hangslotschuif

Plane latch for padlock

Verrou à porte-cadenas plat

Schlossriegel gerade



Art. Nr.	EAN Code	b [mm]	l [mm]	s [mm]	Hole pattern Dia. of the hole/nr. of holes	
FG03360021005	5410439589086	45	100	2	Ø4,6/8	10
FG03360021205	5410439589093	55	120	2	Ø4,5/8	10
FG03360021405	5410439589109	55	140	2	Ø4,5/8	5
FG03360021605	5410439589116	65	160	2	Ø4,5/8	5

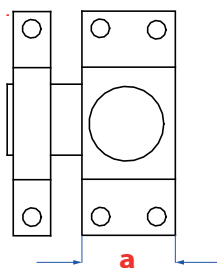

FG340

Draaikrukschuif met veer

Spagnolet with bolt loop

Tarquette pène plat

Drehriegel mit Schlaufen



Art. Nr.	EAN Code	a [mm]	
FG03400420205	5410439391948	20	10
FG03400420305	5410439391955	30	10
FG03400420405	5410439534406	40	10

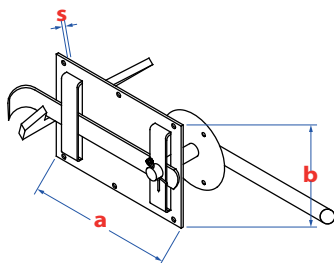

FG341

Boerenklinkstel met inslagneus

Farmer gate latch

Fermeture à l'ancienne

Gartentorfall mit Einschlagnase



Art. Nr.	EAN Code	a [mm]	b [mm]	s [mm]	Hole pattern Dia. of the hole/nr. of holes	
FG03410011200855	5410439631693	120	85	2	Ø3/4 - Ø3,6/6	10

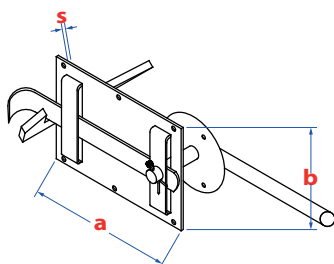

FG341

Boerenklinkstel met inslagneus

Farmer gate latch

Fermeture à l'ancienne

Gartentorfall mit Einschlagnase



Art. Nr.	EAN Code	a [mm]	b [mm]	s [mm]	Hole pattern Dia. of the hole/nr. of holes	
FG03410031200855	5410439769082	120	85	2	Ø3/4 - Ø3,6/6	10

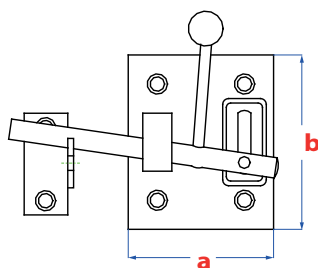
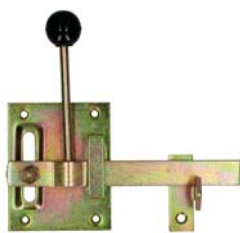

FG343

Tuinhekssluiting

Garden gate latch

Fermeture porte de jardin

Gartentorfall



Art. Nr.	EAN Code	a [mm]	b [mm]	Hole pattern Dia. of the hole/nr. of holes	
FG03430021001805	5410439425001	100	180	Ø4,8/4 - Ø5,8/2	10

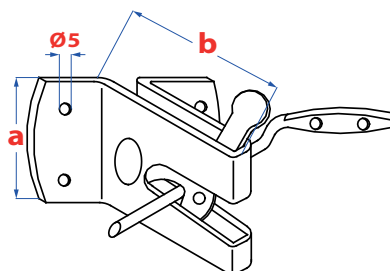

FG344

Hekssluiting automatisch

Gate latch automatic

Fermeture porte de jardin automatique

Gartentorfall automatisch



Art. Nr.	EAN Code	a [mm]	b [mm]	Hole pattern Dia. of the hole/nr. of holes	
FG03440010450605	5410439441735	45	60	Ø5/6	10

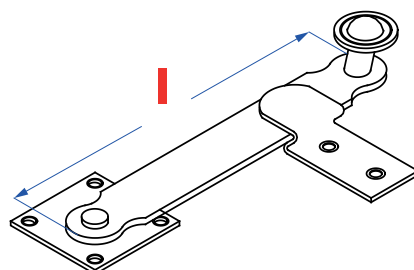

FG345

Hekklink

Gate latch

Fermeture barrière

Gartentorfall



Art. Nr.	EAN Code	l [mm]	Hole pattern Dia. of the hole/nr. of holes	
FG03450021605	5410439369053	160	Ø4,6/6	1



Hekklink

Fermeture barrière

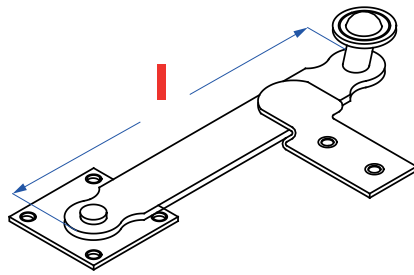

Gate latch

Gartentorfall

FG345

Deltacoll®
Black

Art. Nr.	EAN Code	l [mm]	Hole pattern Dia. of the hole/nr. of holes	
FG03450031605	5410439589123	160	Ø4,6/6	5



Luikoverslag

Fermeture de volet

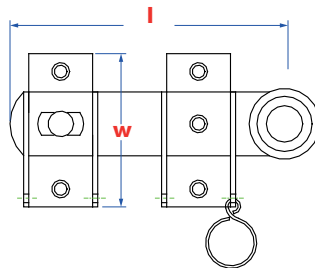

Kick-over latch

Schlagladenüberwurf

FG348

GZ
yellow
zinc pl.

Art. Nr.	EAN Code	w [mm]	l [mm]	
FG03480020601305	5410439367769	60	130	1



Luikoverslag

Fermeture de volet

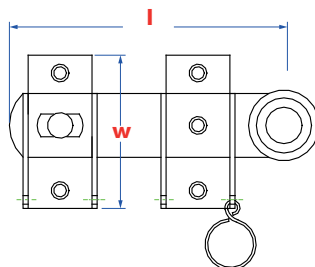

Kick-over latch

Schlagladenüberwurf

FG348

Deltacoll®
Black

Art. Nr.	EAN Code	w [mm]	l [mm]	
FG03480030601305	5410439367776	60	130	1

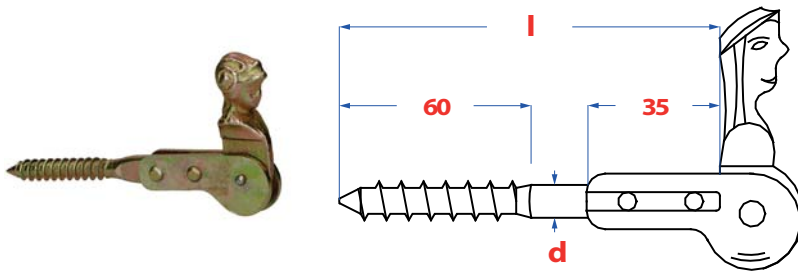

FG349

Herderinnekopje met houtdraad
Arrêt tête bergère à vis à bois

Shutter catch "shepherdess" wood thread
Fensterlade-Feststeller mit Holzgewinde



Art. Nr.	EAN Code	d [mm]	l [mm]	
FG0349002101155	5410439393157	10	115	10

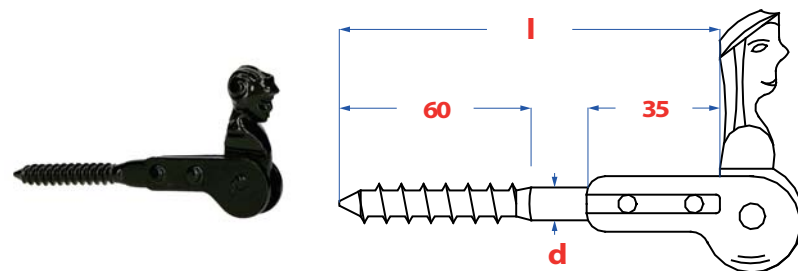

FG349

Herderinnekopje met houtdraad
Arrêt tête bergère à vis à bois

Shutter catch "shepherdess" wood thread
Fensterlade-Feststeller mit Holzgewinde



Art. Nr.	EAN Code	d [mm]	l [mm]	
FG0349003101155	5410439393164	10	115	10

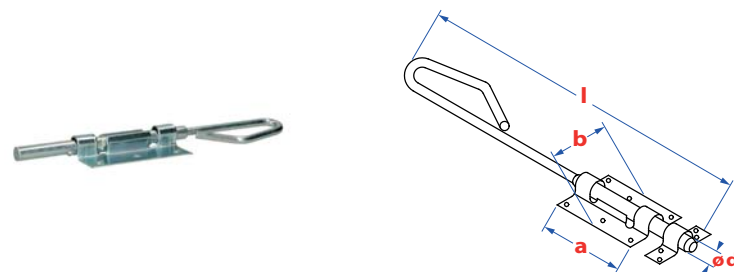

FG351

Bajonetgrendel
Verrou à baionette

Barrel bolt
Bolzenstangenriegel



Art. Nr.	EAN Code	d [mm]	l [mm]	b [mm]	a [mm]	
FG03510010002005	5410439441797	10	200	60	80	6
FG03510010002505	5410439441803	10	250	60	80	6
FG03510010003005	5410439441810	10	300	60	80	6
FG03510010003205	5410439323895	15	320	70	100	5
FG03510010004005	5410439323918	15	400	70	100	5
FG03510010005005	5410439323932	15	500	70	100	5
FG03510010006005	5410439323956	15	600	70	100	5
FG03510010008005	5410439605328	15	800	70	100	5
FG03510010010005	5410439323963	15	1000	70	100	5

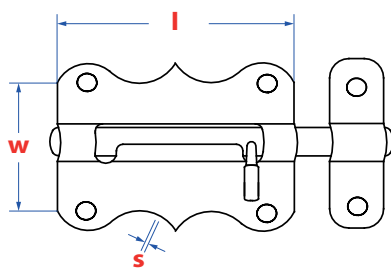

FG352

Amerikaanse grendel

Slide bolt - American type

Verrou à glissiere - Forme Américaine

Grendelriegel - Amerikanische Form



Art. Nr.	EAN Code	w [mm]	l [mm]	s [mm]	Hole pattern Dia. of the hole/nr. of holes	
FG03520010000355	5410439323987	35	38	1	Ø4/6	12
FG03520010000405	5410439324007	40	43	1	Ø4/6	12
FG03520010000505	5410439337564	50	50	1	Ø4/6	12
FG03520010000705	5410439324021	70	60	1	Ø4/6	12

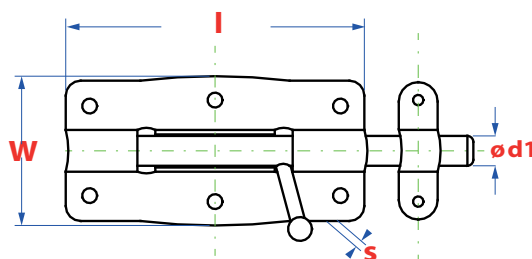

FG353

Plaatgrendel

Slide bolt

Verrou à glissiere

Grendelriegel



Art. Nr.	EAN Code	w [mm]	l [mm]	s [mm]	d1 [mm]	Hole pattern Dia. of the hole/nr. of holes	
FG03530010000805	5410439324045	80	50	1,5	10	Ø4,5/6	12
FG03530010001005	5410439324069	100	50	1,5	-	Ø4,5/8	12
FG03530010001205	5410439324083	120	81	1,5	13	Ø5,3/10	12

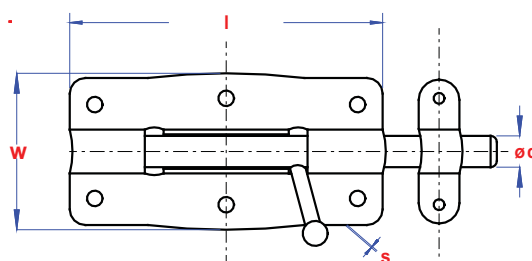

FG353

Plaatgrendel

Slide bolt

Verrou à glissiere

Grendelriegel



Art. Nr.	EAN Code	w [mm]	l [mm]	s [mm]	d1 [mm]	Hole pattern Dia. of the hole/nr. of holes	
FG03530030000655	5410439425209	65	50	1	10	-	12
FG03530030000805	5410439389266	80	55	1,25	12	-	12
FG03530030000905	5410439589208	90	65	1,5	14	-	12
FG03530030001005	5410439389310	100	50	-	-	Ø5,3/6 - Ø5,3/4	12

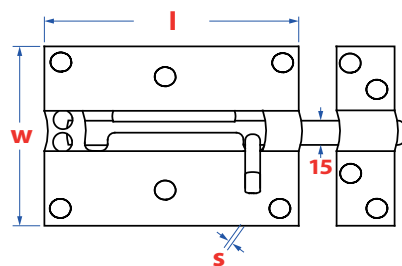

FG354

Hangslotgrendel met oogslot achteraan

Slide bolt for padlock

Verrou à porte-cadenas

Grendelriegel - abschliessbar



Art. Nr.	EAN Code	w [mm]	l [mm]	s [mm]	
FG03540011000755	5410439324106	100	75	1,5	12

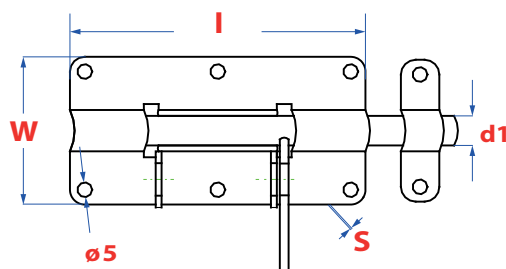

FG355

Hangslotgrendel

Slide bolt for padlock

Verrou à porte-cadenas

Grendelriegel - abschliessbar



Art. Nr.	EAN Code	w [mm]	l [mm]	s [mm]	d1 [mm]	Hole pattern Dia. of the hole/nr. of holes	
FG03550010501005	5410439324137	50	100	1,5	Ø10	Ø4,2/6	12

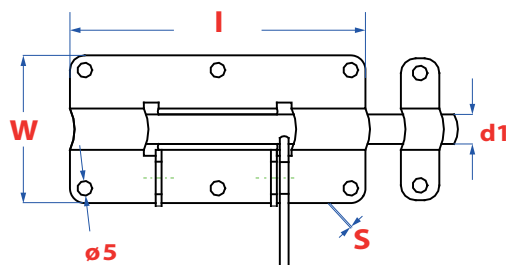

FG355

Hangslotgrendel

Slide bolt for padlock

Verrou à porte-cadenas

Grendelriegel - abschliessbar



Art. Nr.	EAN Code	w [mm]	l [mm]	s [mm]	d1 [mm]	Hole pattern Dia. of the hole/nr. of holes	
FG03550030700805	5410439389419	70	80	1,5	Ø12	Ø5/8	10
FG03550030850905	5410439389402	85	90	-	-	Ø5/8	10

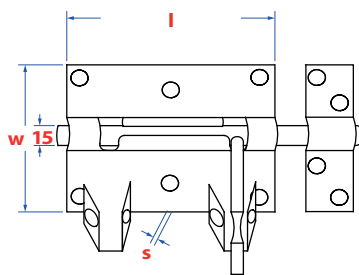

FG356

Hangslotgrendel
Verrou à porte-cadenas

Slide bolt for padlock
Grendelriegel - abschliessbar



Art. Nr.	EAN Code	w [mm]	l [mm]	s [mm]	
FG03560010701005	5410439269674	70	100	1,5	12

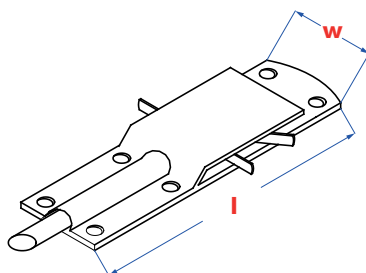

FG357

Varkenshok veiligheidsrendel
Verrou d'étable de sécurité

Security bolt for pig stable
Sicherheitsstallriegel



Art. Nr.	EAN Code	w [mm]	l [mm]	Hole pattern Dia. of the hole/nr. of holes	
FG03570010652005	5410439442619	65	200	Ø5,1/6 - Ø3,5/1	5

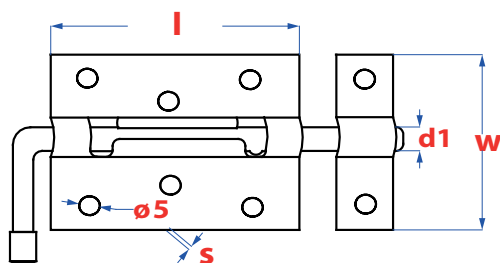

FG358

Pistoolgrendel
Verrou pistolet

Pistol latch
Pistolriegel



Art. Nr.	EAN Code	w [mm]	l [mm]	s [mm]	d1 [mm]	Hole pattern Dia. of the hole/nr. of holes	
FG03580020600805	5410439389457	60	80	1,5	Ø12	Ø5/8	10

Miscellaneous

Diversen

Divers

Sonstiges



A blue-tinted photograph showing a hand holding a microscope slide over a multi-well plate. The image is used as a background for the text.

Miscellaneous

Diversen

Divers

Sonstiges

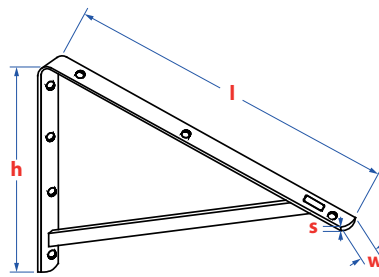

FG380

Plankendrager met steun - Zwaar type

Shelf bracket - Heavy type

Support de table - Lourd

Konsolenstutze - schwer



Art. Nr.	EAN Code	w [mm]	l [mm]	s [mm]	h [mm]	
FG03800012003005	5410439324144	30	300	4	200	10
FG03800012504005	5410439337427	30	400	4	250	10
FG03800013305005	5410439337441	30	500	4	330	10

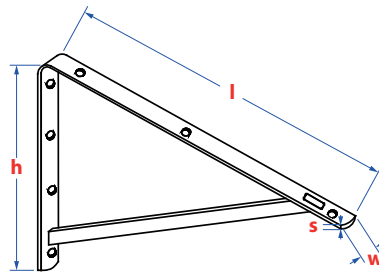

FG380

Plankendrager met steun - Zwaar type

Shelf bracket - Heavy type

Support de table - Lourd

Konsolenstutze - schwer



Art. Nr.	EAN Code	w [mm]	l [mm]	s [mm]	h [mm]	
FG03800742003005	5410439324168	30	300	4	200	10
FG03800742504005	5410439324182	30	400	4	250	10
FG03800743305005	5410439324205	30	500	4	330	10

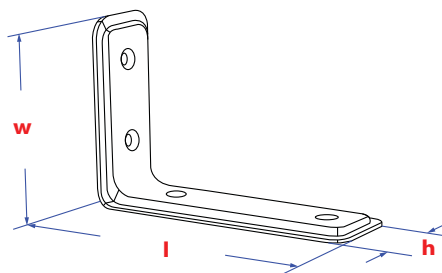

FG381

Plankendrager zonder steun

Shelf bracket without support

Console sans support

Konsole ungestützt



Art. Nr.	EAN Code	w [mm]	l [mm]	h [mm]	
FG03810031150805	5410439273145	115	80	40	10
FG03810031601055	5410439273169	160	105	40	10
FG03810032351605	5410439273176	235	160	40	10
FG03810033152005	5410439273183	315	200	40	6

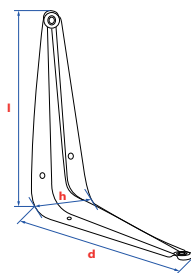

FG382

Geperste plankendrager - Type 1

Pressed shelf bracket - Type 1

Console emboutie - Type 1

Blechkonsole - Typ 1



Art. Nr.	EAN Code	d [mm]	l [mm]	h [mm]	
FG03820711001255	5410439273268	100	125	34	20
FG03820711251505	5410439273251	125	150	35	20
FG03820711502005	5410439273244	150	200	41	20
FG03820712002505	5410439273237	200	250	42	20
FG03820712503005	5410439273220	250	300	45	20
FG03820713003505	5410439273213	300	350	48	20

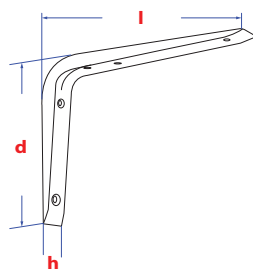

FG383

Geperste plankendrager - Type 2

Pressed shelf bracket - Type 2

Console emboutie - Type 2

Blechkonsole - Typ 2



Art. Nr.	EAN Code	d [mm]	l [mm]	h [mm]	
FG03830711251505	5410439055833	125	150	24	10
FG03830711502005	5410439273282	150	200	26	12
FG03830712002505	5410439273299	200	250	30	12
FG03830712503005	5410439273275	250	300	34	12



Ornamentale plankendrager

Console ornamental

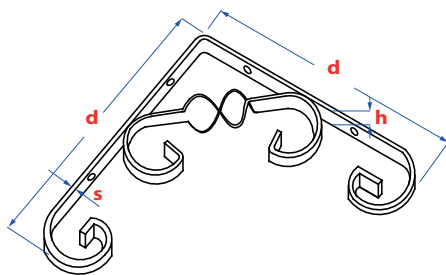

Ornamental shelf bracket

Konsole ornamental

FG384

Deltacoll®
Black

Art. Nr.	EAN Code	d [mm]	l [mm]	s [mm]	h [mm]	Hole pattern Dia. of the hole/nr. of holes	
FG03840031001005	5410439273343	100	100	3	16	Ø5/5	10
FG03840031501505	5410439273350	150	150	3	13	Ø5/5	10
FG03840032002005	5410439273367	200	200	3	13	Ø5/5	10
FG03840032502505	5410439273374	250	250	3	13	Ø5/5	10



Ornamentale plankendrager

Console ornamental

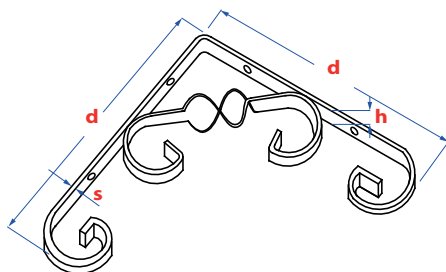

Ornamental shelf bracket

Konsole ornamental

FG384

GP
plasticized

Art. Nr.	EAN Code	d [mm]	l [mm]	s [mm]	h [mm]	Hole pattern Dia. of the hole/nr. of holes	
FG03840711001005	5410439273336	100	100	3	16	Ø5/5	10
FG03840711501505	5410439273329	150	150	3	13	Ø5/5	10
FG03840712002005	5410439273312	200	200	3	13	Ø5/5	10
FG03840712502505	5410439273305	250	250	3	13	Ø5/5	10



Plankendrager

Console

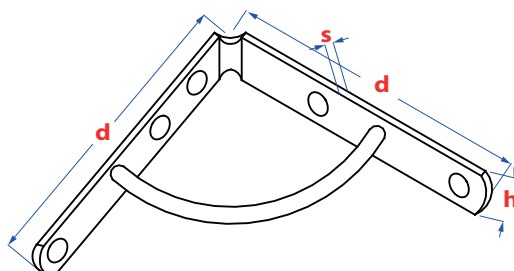

Shelf bracket

Konsole

FG385

Deltacoll®
Black

Art. Nr.	EAN Code	d [mm]	l [mm]	s [mm]	h [mm]	
FG03850031401405	5410439273435	140	140	3	20	4
FG03850031901905	5410439273428	190	190	5	20	4
FG03850032402405	5410439273411	240	240	5	20	4

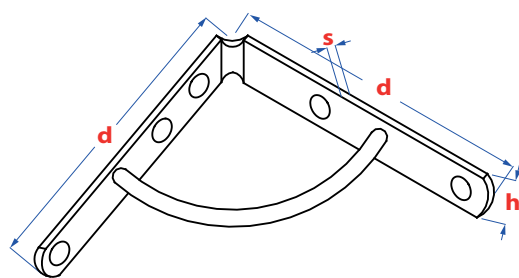

FG385

Plankendrager

Shelf bracket

Console

Konsole

GP
plasticized

Art. Nr.	EAN Code	d [mm]	l [mm]	s [mm]	h [mm]	
FG03850711401405	5410439273404	140	140	3	20	4
FG03850711901905	5410439273398	190	190	5	20	4
FG03850712402405	5410439273381	240	240	5	20	4

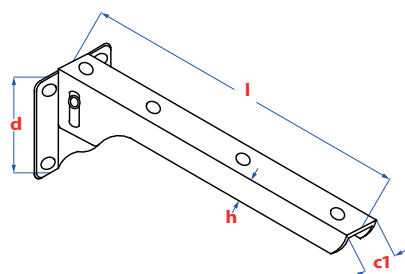

FG388

Inklapbare plankendrager

Foldable shelf bracket

Console pliable

Konsole klappbar



Art. Nr.	EAN Code	d [mm]	l [mm]	c [mm]	h [mm]	
FG03880010602005	5410439273190	60	200	20	15	2
FG03880010603005	5410439273206	60	300	20	15	2

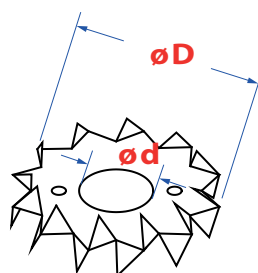

FG413

Kramplaat - Dubbelzijdig getand

Timber connector - Double sided

Crampon - Double denture

Holzverbinder - Dorne zweiseitig

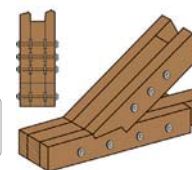

DoPn° FG413001

SZ
sendzimir
zinc pl.

Art. Nr.	EAN Code	d [mm]	l [mm]	Hole pattern Dia. of the hole/nr. of holes	
FG04130010480175*	5410439646949	48	17	Ø3,5/2 - Ø17/1	200
FG04130010750265*	5410439646963	75	26	Ø5/2 - Ø26/1	100

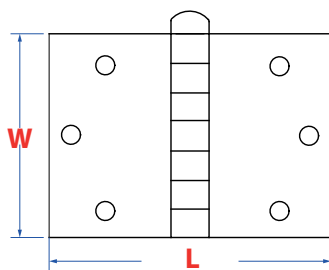

FG421

Gerolde knopscharnier - Rechte hoeken

Rolled knuckle hinge - Straight corners

Charnière à noeud - Angle droite 90°

Stangenscharnier gerollt - Winkel 90°



Art. Nr.	EAN Code	w [mm]	l [mm]	
FG04210010760765	5410439340250	76,2	76	24

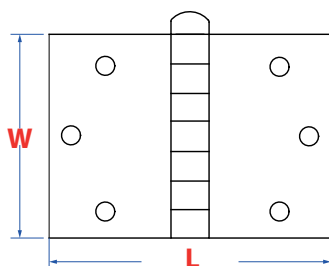

FG421

Gerolde knopscharnier - Rechte hoeken

Rolled knuckle hinge - Straight corners

Charnière à noeud - Angle droite 90°

Stangenscharnier gerollt - Winkel 90°



Art. Nr.	EAN Code	w [mm]	l [mm]	
FG04210020760765	5410439340274	76,2	76	24

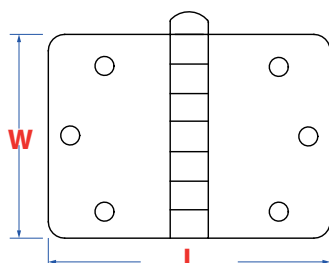

FG422

Gerolde scharnier - Ronde hoeken en bolkop

Rolled hinge - Round corners and head

Charnière roulee - Angle arrondi et tête ronde

Geroldes scharn. - Hecke abger. und Rundkopf



Art. Nr.	EAN Code	w [mm]	l [mm]	
FG04220020760765	5410439340298	76,2	76	24

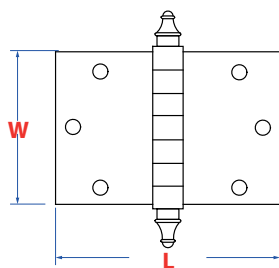

FG423

Gerolde knopsch. - Rechte hoeken en vaaskop

Rolled knuckle hinge - Straight corners-plug

Charn. à noeuds roulee - Angle 90°-vase

Stangenscharnier gerollt - Winkel 90°-stopfen



Art. Nr.	EAN Code	w [mm]	l [mm]	
FG04230010760765	5410439340335	76,2	76	24

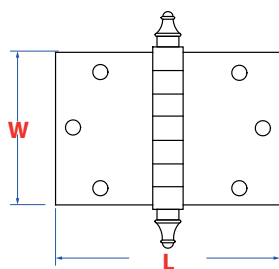

FG423

Gerolde knopsch. - Rechte hoeken en vaaskop

Rolled knuckle hinge - Straight corners-plug

Charn. à noeuds roulee - Angle 90°-vase

Stangenscharnier gerollt - Winkel 90°-stopfen



Art. Nr.	EAN Code	w [mm]	l [mm]	
FG04230020760765	5410439340359	76,2	76	24

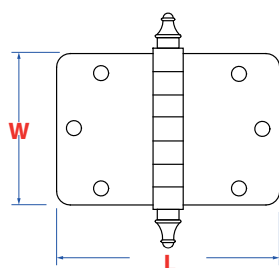

FG424

Gerolde knopsch. - Ronde hoeken en vaaskop

Rolled knuckle hinge - Rounded corners-plug

Charn. à noeuds roulee - Angl. arondis-vase

Stangenscharn. gerollt - Winkel abger.-stopfen



Art. Nr.	EAN Code	w [mm]	l [mm]	
FG04240020760765	5410439324229	76,2	76	24

Construction & Wall ties

Constructie & Muurbevestigingen

Construction & Fixations pour mur

Konstruktion & Mauerverbindungen

Construction & Wall ties

Constructie & Muurbevestigingen

Construction & Fixations pour mur

Konstruktion & Mauerverbindungen

FG517

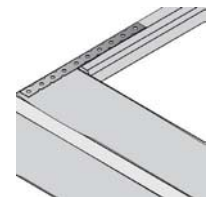
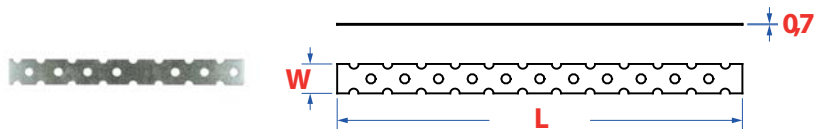

Lijmkoppelstrip

Wall junction strip

Raccord à coller

Mauerverbinder



Art. Nr.	EAN Code	w [mm]	l [mm]	s [mm]	Hole pattern Dia. of the hole/nr. of holes	
FG05170010222005	5410439567695	22	200	0,7	Ø7/7	250
FG05170010223005	5410439567718	22	300	0,7	Ø7/11	250
FG05170010224005	5410439567732	22	400	0,7	Ø7/14	250

FG517

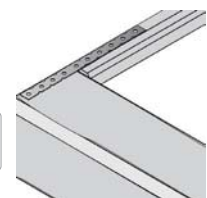
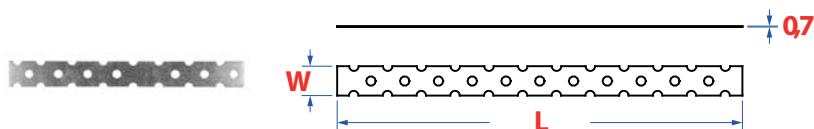

Lijmkoppelstrip

Wall junction strip

Raccord à coller

Mauerverbinder



DoPn° FG517001



Art. Nr.	EAN Code	w [mm]	l [mm]	s [mm]	Hole pattern Dia. of the hole/nr. of holes	
FG0517B000223005*	5410439646734	22	300	0,7	Ø7/11	250

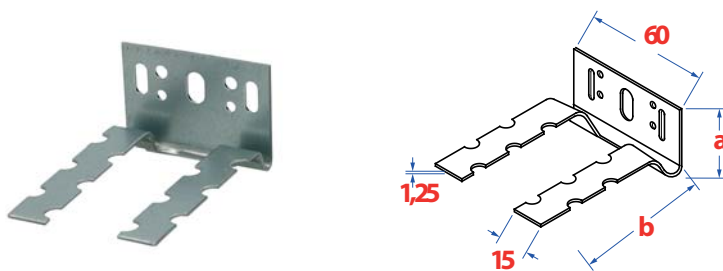

Uizetbaar wandanker

Flexible wall clamp

Ancrage mur dilatant

Wandanker beweglich



DoPn° FG521001



Art. Nr.	EAN Code	a [mm]	b [mm]	Hole pattern Dia. of the hole/nr. of holes	
FG052100140885*	5410439567756	40	88	Ø4/2 - Ø5/2	100



Veeranker

Ancrage dilatant

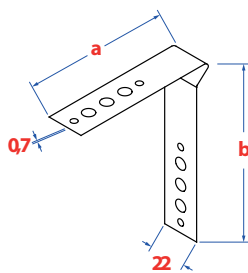

Spring anchor

Federanker



DoPn° FG523001

FG523



Art. Nr.	EAN Code	a [mm]	b [mm]	Hole pattern Dia. of the hole/nr. of holes	
FG0523001901035*	5410439567770	90	103	Ø4/4 - Ø7/6	100



Glijanker

Tige de dilatation lisse

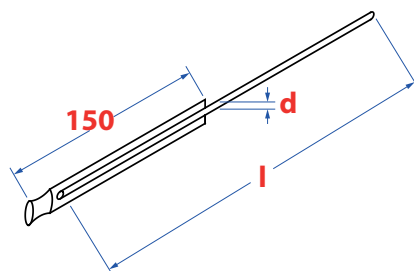

Slip tie

Gleitanker

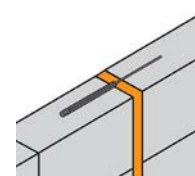

FG526



Art. Nr.	EAN Code	d [mm]	l [mm]	
FG0526001063005	5410439567794	6	300	100



Kozijnanker met houtdraad

Fixation de chambranle filet bois



Window frame anchor wood thread

Zargenanker mit Holzgewinde

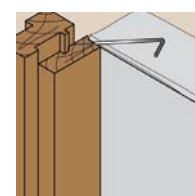

FG531



Art. Nr.	EAN Code	d [mm]	l [mm]	h [mm]	
FG0531001061505	5410439233057	6	150	40	100
FG0531001062005	5410439233064	6	200	50	100
FG0531001062505	5410439233071	6	250	60	100



Lijmkozijnanker - l + r

Ancre chambranle à coller - g + d

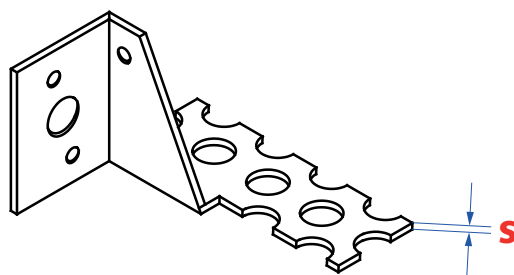

Frame anchor - l + r

Zargenanker zum verkleben - l + r

FG534

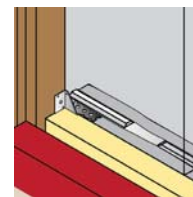

Art. Nr.	EAN Code	s [mm]	Hole pattern Dia. of the hole/nr. of holes	
FG05340010000015	5410439568043	1	Ø4/3 - Ø6/1 - Ø8/3	100



Randbekistingsanker

Ancrage pour margelle

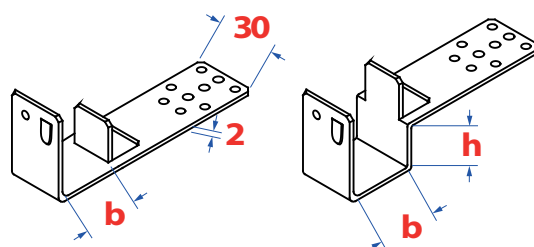

Rim shuttering anchor

Randschalungsanker

FG563

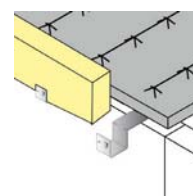

Art. Nr.	EAN Code	b [mm]	h [mm]	Hole pattern Dia. of the hole/nr. of holes	
FG05630010320005	5410439646826	32	-	Ø3/5 - Ø4,5/2 - Ø6,5/1	100
FG05630010320125	5410439646840	32	12	Ø3/7 - Ø4,5/2 - Ø6,5/1	100
FG05630010320225	5410439646864	32	22	Ø3/7 - Ø4,5/2 - Ø6,5/1	100
FG05630010320325	5410439646888	32	32	Ø3/5 - Ø4,5/2 - Ø6,5/1	100



Muurplaatanker plaat centrisch

Tirant de mur plaque centrée

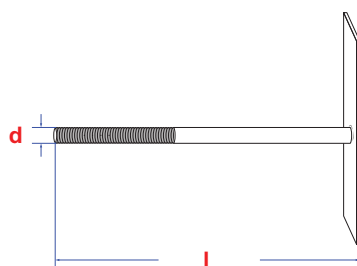

Wall anchor plate centre

Steinanker platte zentrisch

FG586



Art. Nr.	EAN Code	d [mm]	l [mm]	
FG05860011206005	5410439280037	12	600	10

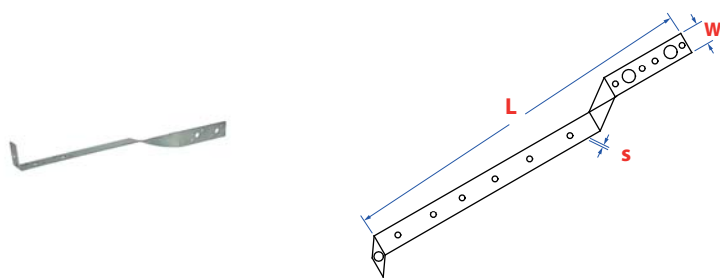

FG599

Stormanker

Storm anchor

Ancrage tempête

Windsoganker



Art. Nr.	EAN Code	w [mm]	l [mm]	s [mm]	Hole pattern Dia. of the hole/nr. of holes	
FG05990010304005	5410439360869	30	400	2	Ø3,7/10 - Ø8,8/2	25

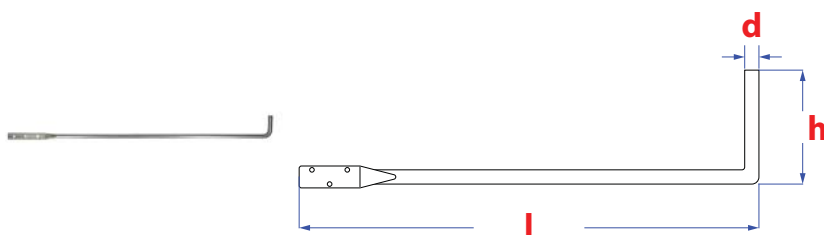

FG601

Opwaaianker

Storm anchorage

Ancrage tempête

Windsoganker



Art. Nr.	EAN Code	d [mm]	l [mm]	Hole pattern Dia. of the hole/nr. of holes	
FG06010011006005	5410439568104	10	600	Ø3/6	25

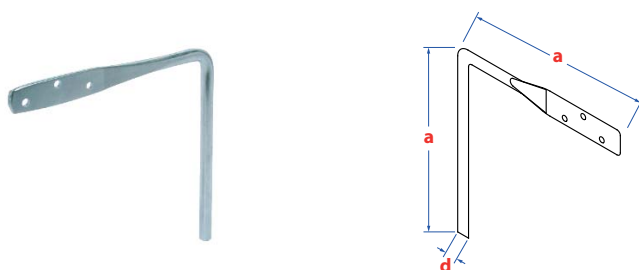

FG606

Bintanker

Cramp iron

Ancrage bois/maçonnerie

Balkenanker



Art. Nr.	EAN Code	d [mm]	a [mm]	Hole pattern Dia. of the hole/nr. of holes	
FG06060012402405	5410439568128	14,5	240	Ø3/7	20

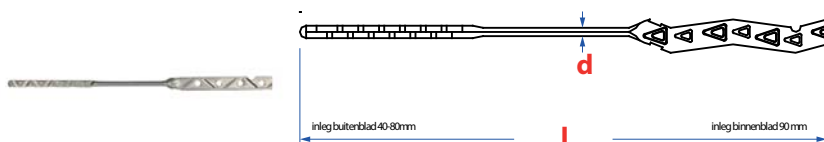

Prikspouwanker

Crochet mur creux à coller

Thin joint tie

Prik-Luftschichtanker

FG651

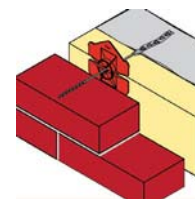

Art. Nr.	EAN Code	d [mm]	l [mm]	
FG0651A000402505	5410439568791	4	250	500
FG0651A000402805	5410439568807	4	280	500

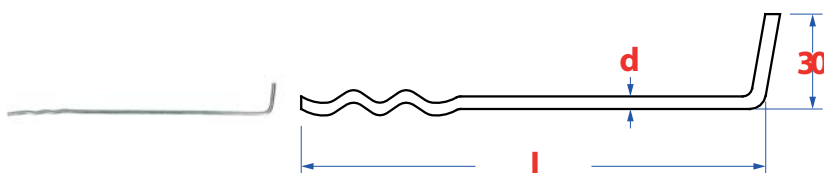

Universeel L-spouwanker

Crochet mur en L universel

Universal wall tie - L type

Universal L-Luftschichtanker

FG661

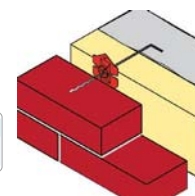

DoPn° FG661001



Art. Nr.	EAN Code	d [mm]	l [mm]	
FG06610013602005*	5410439568814	3,6	200	250
FG06610013602305*	5410439568838	3,6	230	250
FG06610013602605*	5410439569279	3,6	260	250
FG06610013602905*	5410439569286	3,6	290	250

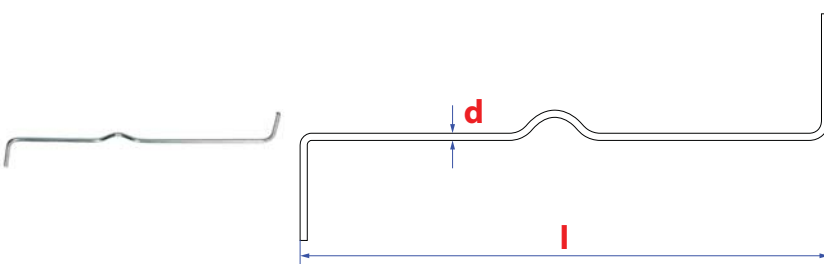

Spouwanker - Mono

Crochet mur - Mono

Wall tie - Mono

Luftschichtanker - Mono

FG663



Art. Nr.	EAN Code	d [mm]	l [mm]	
FG06630013201805	5410439169264	3,2	180	1000
FG06630013502105	5410439169271	3,5	210	500

FG664

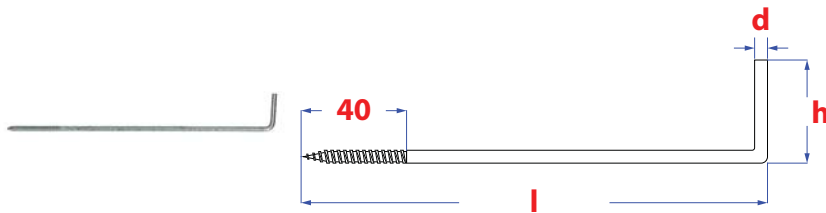

L-spouwanker met houtdraad

Crochet mur à filet bois - Forme L

Wall tie with wood thread - L type

Luftschichtanker mit Holzgewinde - Form L



Art. Nr.	EAN Code	d [mm]	l [mm]	
FG06640013501804	5410439481250	3,5	180	100
FG06640013501805	5410439055895	3,5	180	1000
FG06640013502104	5410439481298	3,5	210	100
FG06640013502105	5410439169295	3,5	210	500

FG671

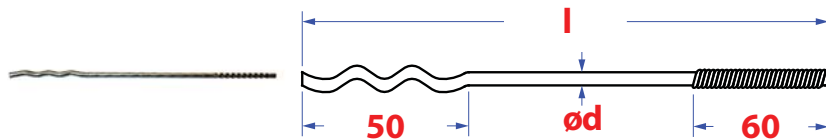

Slagspouwanker

Crochet mur creux à clouer

Selftapping wall tie

Dübelanker mit Einschlaggewinde



DoPn° FG671001



Art. Nr.	EAN Code	d [mm]	l [mm]	
FG06710014001905	5410439569293	4	190	250
FG06710014002205	5410439569309	4	220	250
FG06710014002505	5410439569316	4	250	250
FG06710014002755*	5410439623803	4	275	250



pgb-Europe nv
Logistics centre

Gontrode Heirweg 170
9090 Melle
Belgium
T: +32 9 272 70 70
F: +32 9 272 70 99
e-mail: info@pgb-europe.com

www.pgb-europe.com

pgb-Polska
Production plant

Ul. Fryderyka Wilhelma Redena 3
41 - 807 Zabrze
Polska
T: +48 (32) 330 26 10
F: +48 (32) 330 26 20
e-mail: biuro@pgb-polska.com

www.pgb-polska.com

pgb-France
Sales office

25 Rue du Champ des Oiseaux
59230 Saint-Amand-les-Eaux
France
T: +33 (0)3 27 21 56 80
F: +33 (0)3 27 30 31 16
e-mail: info@pgb-france.com

www.pgb-france.com